









I-CONNECT-BOX BP 15.0000.0001

Type	SDB	SDH	SDP	SPP	SBS	MDO
Description	Single/Direction/ basic	Single/Direction/Hall	Singel/Direction/ Position	Single/Position/ Position	Singel/Bus/Status	Multiple/Direction/ Override
Key letter	A	B	C	D	E	F
No/Color						
1 Yellow	RS485 TX-+A	RS485 TX-+A	RS485 TX-+A	RS485 TX-+A	RS485 TX-+A	RS485 TX-+A
2 Green	RS485 RX -B	RS485 RX -B	RS485 RX -B	RS485 RX -B	RS485 RX -B	RS485 RX -B
3 Orange	GND Signal	Hall output	GND Signal	GND Signal	GND Signal	GND Signal
4 Black	GND Power	GND Power	GND Power	GND Power	GND Power	GND Power
5 White	Not used	Hall A output	Position output	5-10 reference	Not used	Override
6 Brown	Dir. IN	Dir. IN	Dir. IN	Pos ok/stop input	Error out	Dir. IN
7 Blue	Dir. OUT	Dir. OUT	Dir. OUT	Position input	Stop input	Dir. OUT
8 Red	Power 12/24 V	Power 12/24 V	Power 12/24 V	Power 12/24 V	Power 12/24 V	Power 12/24 V
Jumper setting						

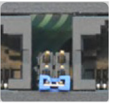

**I-CONNECT-BOX
BP 15.0000.0001**

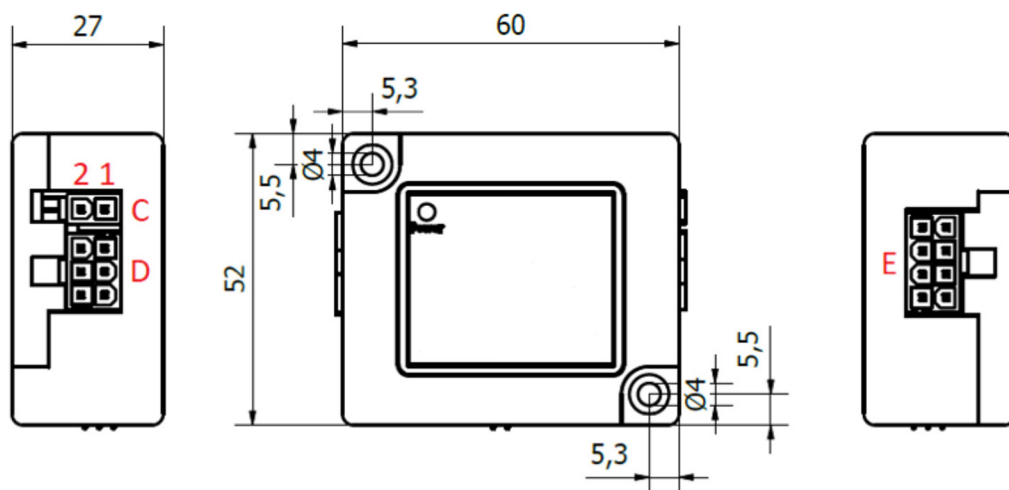
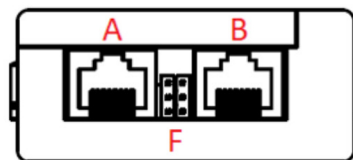

Dimensions in mm

- A: RJ45 type, connection for the programming cable
- B: RJ45 type, connection for routing to the next I-Connect Box with a I-Connect cable (routing sequence is B to A...B to A)
- C: 2 pin Molex Mini-Fit, power supply input. Pin 1: +12/24 VDC, pin 2: GND
- D: 6 pin Molex Mini-Fit, connection for a EasyE-i handset BP10.1000.1901
- E: 8 pin Molex Mini-Fit, connection for actuators
- F: Jumper settings (see page 1)

Single or multiple (MDO)

EasyE-i-line actuators with key letters A-B-C-D-E are all „Single“ actuators, meaning that you cannot synchronize multiple actuators. However, it is possible to address up to 10 „single“ actuators in the same system.

This limitation is caused by limited bandwidth, but with additional equipment the theoretical limit is increased to addressing up to 128 easyE-i-line actuators in the same system.

All configurations of easyE-i-line actuators (A-E) have different options as displayed in the overview. EasyE-i-line actuators (A-E) can be connected to the i-Connect Box / i-Connect Box DIN (one to one) as a single actuator, or multiple actuators if routed with i-Connect Boxes cables. Note routing sequence is B to A ... B to A ... B to A (also called daisychain).

Each easyE-i-line actuator has its own address 1 to 128 (default is 8) and Modbus communicate with all addresses.

Handsets or other, such as potentiometers, dry contacts or analog PLC outputs, must be connected to every easyE-i-line actuator individually.

Configurations: A-B-C-D-E

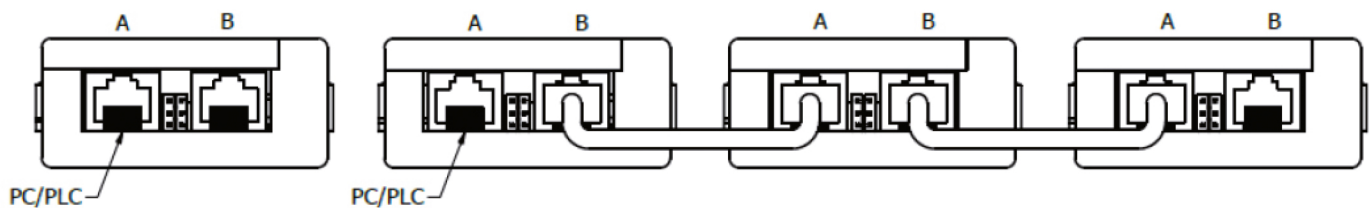

EasyE-i-line actuators with the key letter F are always multiple (minimum 2 and maximum 8 pcs). F-configuration easyE-i-line actuators are for synchronous use only. It is possible to override the synchronous function and run a single easyE-i-line actuator only. The override function is activated by pulling pin 7 (in 8-pin Molex) or pin 5 (white wire in screw terminal) down. It is now possible to run this actuator alone using the handset connected to the corresponding i-Connect Box DIN

Each easyE-i-line actuator has its own address from 200 to 207. Address 200 is always the Master. If nothing else is agreed when ordering the default address is 200. Up to 8 icons (but minimum 2) may run in the same system, but only the „Master“ (address 200) is controlled by a handset or other, such as, third party dry contacts or PLC.

The „Master“ uses and occupies Modbus for communication with the „Slaves“. Hence, controlling the MDO

MDO master addr. 200

Configurations: F

