



Nano push button switch 145 NT

The compact design of the nano push buttons ensures they are ideal for installation in many applications such as Multi-function handles and mobile machinery keypads. The design features of the 145NT push button allows for maximum functionality in a compact space.

Technical specifications

- Compact design with maximum switching reliability
- Tactile behaviour over the entire service life
- Patented design principle with encapsulated switch housing, IP67 protection class
- Function and night illumination
- Shock and vibration resistant in accordance with DIN IEC 68 Part 2
- Service life > 2 million operating cycles
- Optionally available with NAMUR wiring

Technical drawing

IMAGE 1/1

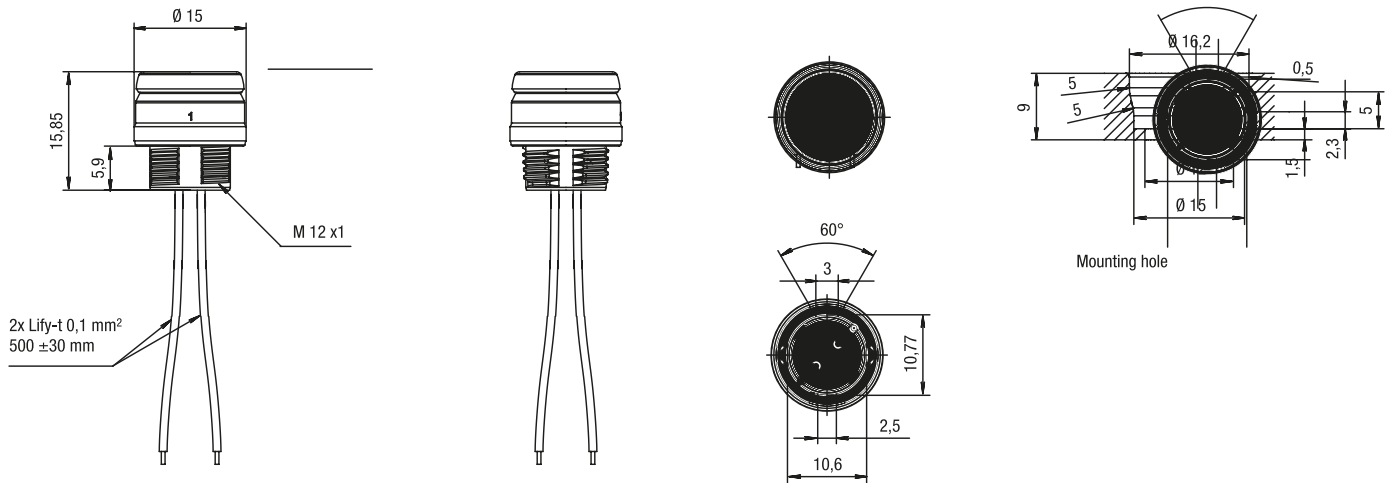

Reed NAMUR circuit with LED

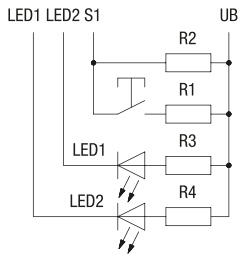

Reed N.O. circuit

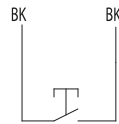

Hall switch open drain circuit

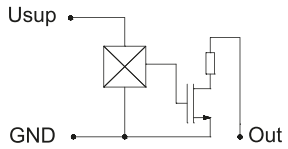

Optional: Hall switch high-side circuit

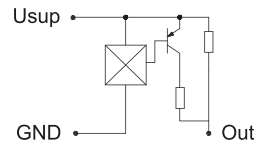

Product options

IMAGE 1/2

Actuator colors

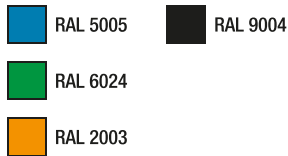

Illumination colours LED

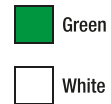

**Actuator colors
Optional**

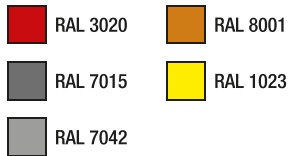

**Illumination colours LED
Optional**



Additional versions are available on request. The push button caps can optionally be printed with symbols. (symbol Ø max. 10 mm).

IMAGE 2/2

Optional icons for push button 145 NT

Icon colour: white translucent

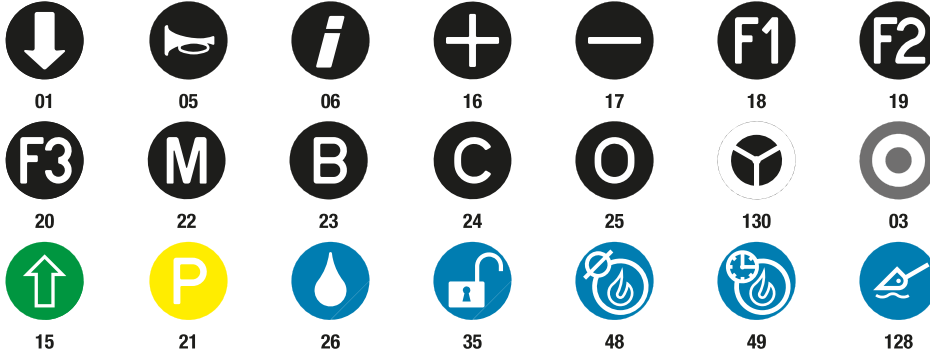

Icon colour: red translucent



Icon colour: black



Additional symbols in accordance with DIN ISO 7000:2008-12 are available on request.

**Optional:
2K nano push button**

Convex push button

Flat push button

Concave push button

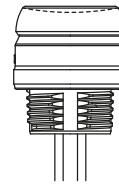
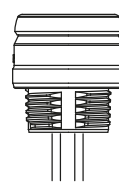
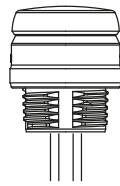

**Optional icon for
2K push button**



**Optional
actuator colours**

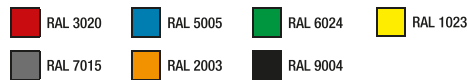

Article characteristics

Attribute	145NTG...	145NTH...
Max. switching voltage	30 V DC	-
Max. switching current	0.3 A	-
Max. switching power	3 W	
Max. switching power	3 VA	5 VA
Contact form	NO	-
Series resistor	-	85 Ohm
Service life, mechanical (Cycles)	2000000	
Protection class, electronic	IP67 DIN EN 60529	
Operating temperature min.	-40 °C	
Max. operating temperature	85 °C	
Min. storage temperature	-40 °C	
Max. storage temperature	85 °C	
Installation	from above	
Mounting type	screwed	
Thread	M12	
Cable length	0.5 m	