

The accessories

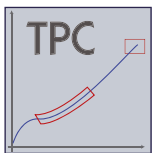
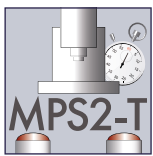
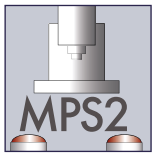
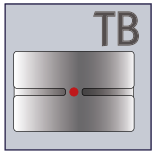

MicroPress[®] is a pneumatic press for smaller capacities with a robust press base. MicroPress[®] types are ideal for joining and shaping applications where components require low pressure and precise stroke depth. Examples are applications in medical engineering, electronics manufacturing and precision mechanics.

Quality features:

- ▶ Square ram
- ▶ Precision ram guide
- ▶ Adjustable stroke length
- ▶ Height-adjustable press head
- ▶ Practically maintenance-free cylinder
- ▶ Low noise

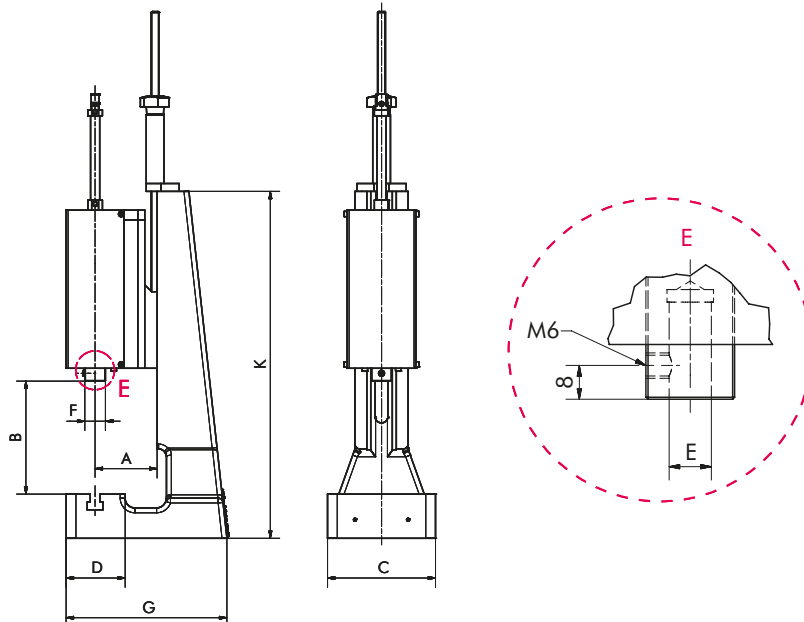
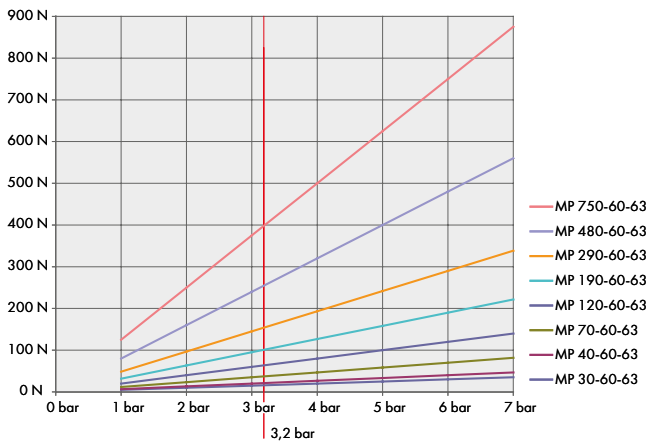
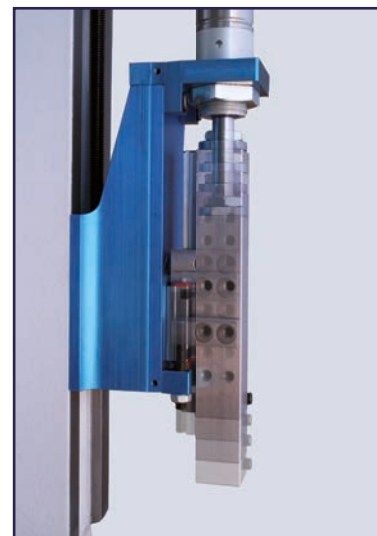
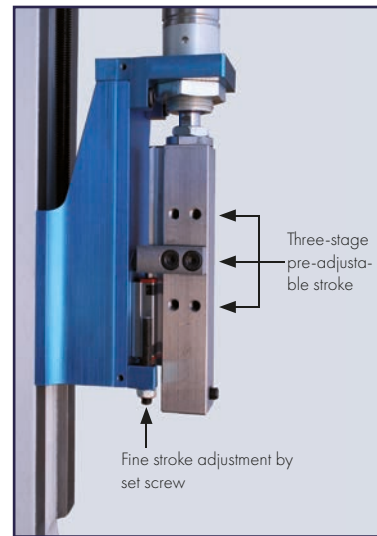

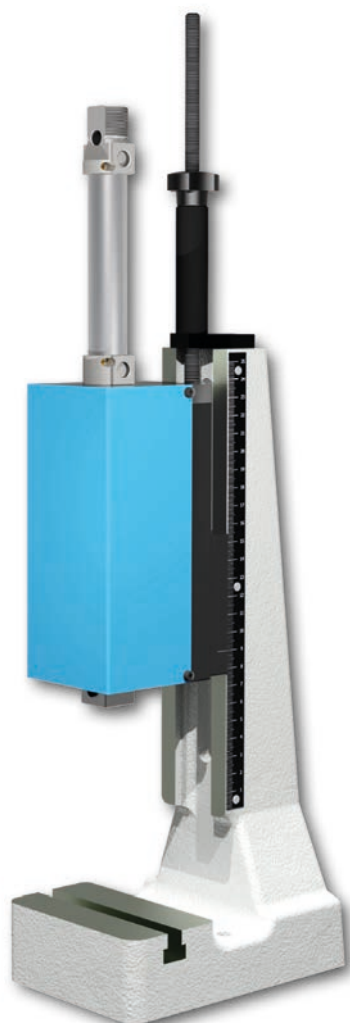

MicroPress 190-60-63

MicroPress®

Type			MP 30-60-63	MP 40-60-63	MP 70-60-63	MP 120-60-63	MP 190-60-63	MP 290-60-63	MP 480-60-63	MP 750-60-63
Capacity at 6 bar		N	30	40	70	120	190	290	480	750
Working stroke max.		mm	60	60	60	60	60	60	60	60
Throat	A	mm	63	63	63	63	63	63	63	63
Daylight	B	mm	43 - 208	43 - 208	43 - 208	43 - 208	43 - 208	43 - 208	43 - 208	43 - 208
Table size	CxD	mm	100 x 65	100 x 65	100 x 65	100 x 65	100 x 65	100 x 65	100 x 65	100 x 65
T-slot width similar to DIN 650		mm	10	10	10	10	10	10	10	10
Ram bore Ø x Depth	E	mm	10H7 x 25	10H7 x 25	10H7 x 25	10H7 x 25	10H7 x 25	10H7 x 25	10H7 x 25	10H7 x 25
Ram Ø	F	mm	21 x 21	21 x 21	21 x 21	21 x 21	21 x 21	21 x 21	21 x 21	21 x 21
Air connection			M5	M5	M5	M5	G _{3/8} "	G _{3/8} "	G _{3/8} "	G _{3/8} "
Air consumption/ 60 mm stroke		l	0.04	0.06	0.08	0.16	0.24	0.38	0.64	1.0
Space requirement	CxG	mm	110 x 164	110 x 164	110 x 164	110 x 164	110 x 164	110 x 164	110 x 164	110 x 164
Stand height	K	mm	355	355	355	355	355	355	355	355
Weight		kg	ca. 9.5	ca. 10	ca. 10	ca. 11	ca. 11	ca. 12	ca. 12	ca. 12

Accessories (see Page 8)	Please specify when ordering.									
Table bore 12H7	TB	TB	TB	TB	TB	TB	TB	TB	TB	TB

The controller model MPS-2 conforms to the safety requirements which must be applied according to the EC Machinery Directive 2006/42/EC and to the standards for the safety of pneumatic presses. MPS-2 two-hand controls fulfil all requirements of type III C according to DIN EN ISO 13851. mäder presses can therefore be used at workstations with manual loading and open tools. Safety is provided here by the controller, which is designed to be both electrically and pneumatically redundant.

MPS-2 controls include a press safety valve, maintenance unit, push button with protective collar, PLC with free interfaces, Ethernet interface and an integrated web server for remote maintenance, as well as an insert for standard micro SD cards and an electronic piece counter.

A key switch can be used to select between 2-hand operation or external control.

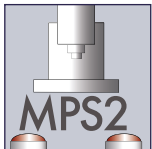

MPS-2
Basic version for two-hand operation.

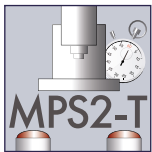

MPS-2 T
MPS-2 controller with additional stop time function. When the press has reached its end position, a timer can be used to determine when the return stroke should take place.

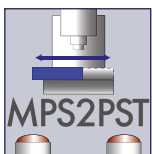

MPS-2 PST
This type of MPS-2 controller is used to control a pneumatic slide table in addition to the press. The scope of supply also includes the stop time function (see MPS-2 T)

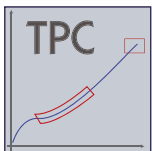

MPS-2 TPC
MPS-2 controller with an additional module TPC-MIDI for force/ displacement monitoring.



Applications:

Joining and assembly processes using presses must today be carried out safely and if possible without retrospective checking. Specified parameters which define the press process must be maintained during production. Only in this way can the quality and safety of the manufactured product be guaranteed. For this reason, TPC-MIDI is used wherever consistent joining processes are required, the progress of which has to be checked and if applicable documented by means of software.

TPC-MIDI monitors the press operation, compares the actual progress with the requirements and subsequently evaluates it. In this way, reject parts can be reliably detected and separated out.

TPC-MIDI can be used both with hand-operated presses and with pneumatic presses. However, the TPC-MIDI is also available as a pure system component if a PLC environment already exists, e.g. in an automation system.

The advantages:

- ▶ TPC-MIDI can be programmed via the membrane keyboard or conveniently using the PC software.
- ▶ TPC-MIDI stores 16 different measuring programs
- ▶ Modern curve evaluation via freely parameterisable windows
- ▶ Evaluation options: Window, trapezoid window, block window, envelop curve, thresholds on the x or y axis.
- ▶ Interfaces: Ethernet and USB. Optional fieldbus integration with PROFIBUS, PROFINET or EtherNet/IP.
- ▶ Force measurement directly in the force characteristic with DMS sensor developed especially for presses.
- ▶ Software for programming and saving monitoring programmes, as well as for documentation of the individual press-fit processes

Clear OK / NOK message

With OK parts, the indicator light is green and the press is ready for the next working stroke.

NOK parts are reliably reported by the TPC-MIDI as an audible signal and by a red indicator light.

The next press stroke cannot be initiated until the error has been acknowledged.



DA 2800-40-130 with MPS-2 TPC

System structure

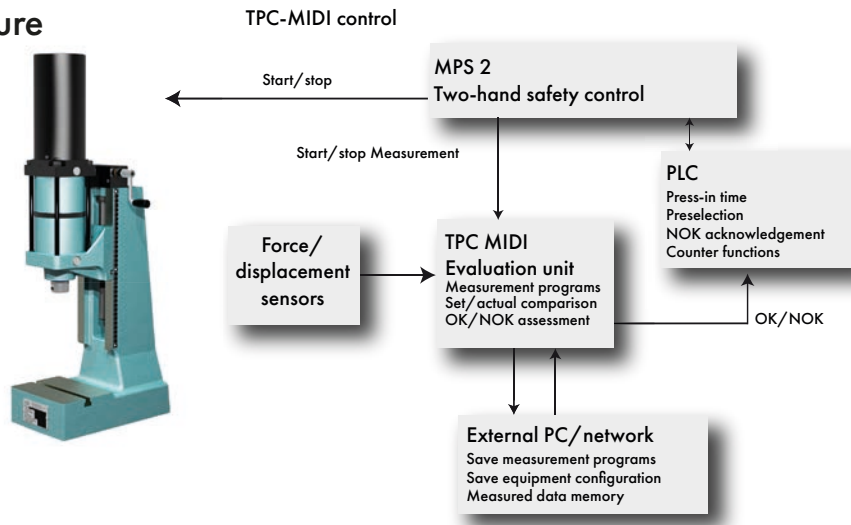

Load cell force sensors for TPC-MIDI

The load cell force sensor is fixed inside the ram bore. The tool holder can be fixed in the hole at the other end of the sensor. The force sensor is therefore always directly in the force flow between the press ram and the tool.

Measurement range	Measured value divergence	Tool holder
0 – 500 N	≤ ± 0.5% of EV	10H7 x 24 mm
0 – 1 kN	≤ ± 0.5% of EV	10H7 x 24 mm
0 – 2 kN	≤ ± 0.5% of EV	10H7 x 24 mm
0 – 5 kN	≤ ± 2.0% of EV	10H7 x 24 mm
0 – 10 kN	≤ ± 2.0% of EV	10H7 x 24 mm
0 – 20 kN	≤ ± 1.0% of EV	10H7 x 24 mm
0 – 50 kN	≤ ± 1.0% of EV	20H7 x 24 mm
0 – 100 kN	≤ ± 1.0% of EV	20H7 x 24 mm

Unless expressly required to the contrary, the load cell force sensor is selected to match the maximum capacity of the press used



Potentiometric travel meter

Travel is measured potentiometrically. The service life of the sensors is 10⁸ movements

Press stroke	Resolution	Linearity error
40 mm	0.025 mm	0.42%
60/80 mm	0.038 mm	0.41%
100 mm	0.050 mm	0.40%
120 mm	0.075 mm	0.40%

Monitoring windows

Pass-through window

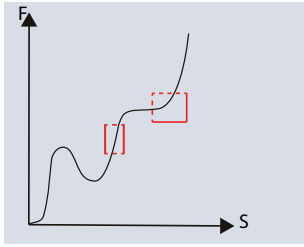

The force/displacement curve must pass through the window from the entry to the exit side as defined without one of the other window boundaries being infringed. The entry and exit sides can be freely selected.

Block window

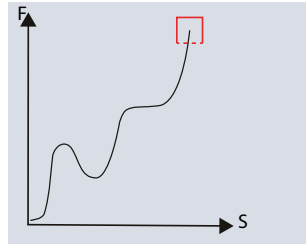

The block window monitors the final values of the press operation. With this type of window, the force/displacement curve must enter the specified entry side and must not leave the window again.

Envelope curve

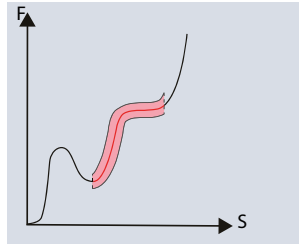

The measuring curve must pass continuously through the envelope curve and must not infringe it. The envelope curve is taught by means of a teach-in process. Its X-axis parameters and the delta-Y, i.e. the force tolerance range, are then defined.

Monitoring window

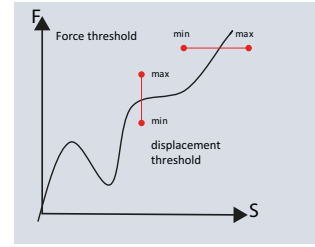

Thresholds define minimum values that must be reached within a certain range and may no longer be undershot. A force threshold (Y-axis) and alternatively a displacement threshold (X-axis) are available.

The reference points of the monitoring windows

The reference points of the monitoring windows on the X-axis can be defined both rigidly and dynamically.

Absolute

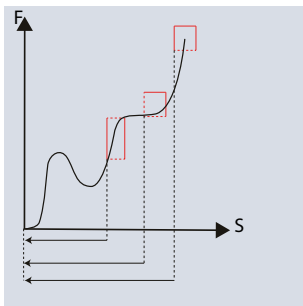

In the case of assembled parts with high repeat accuracy, the calibrated zero point of the displacement sensor on the X-axis is used as the reference point.

Trigger

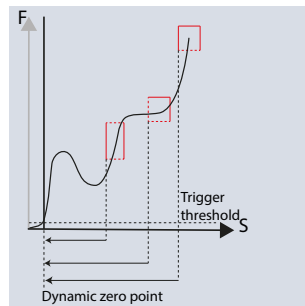

If the assembly sequence is identical as such, but the start of assembly has a major deviation on the X-axis, the beginning of the measurement can be defined by setting a trigger threshold on the Y-axis.

End force

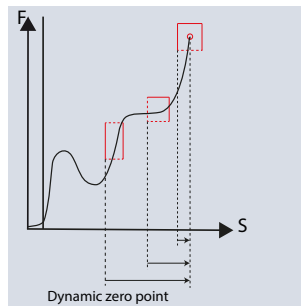

If a measurement with an absolute or a trigger reference point is not useful, the position of the end force (Fmax) on the x-axis can be selected as the reference point. The position of the evaluation window on the X-axis then relates in reverse to this dynamic zero point.

Block window

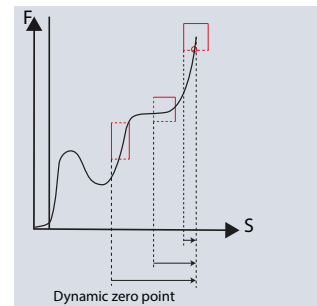

If the end force shows a wide spread, the reference point of the evaluation windows can also be defined using the entry of the curve into the block window. Any values after the block window has been reached are no longer taken into account. The position of the evaluation windows on the X-axis then relates in reverse to this dynamic zero point.

PC Software

TPC-MIDI is supplied as standard with the basic version of the software, with which the configuration of TPC-Midi and measurement programs can be set up and saved.

Equipment configuration

- ▶ Settings or teach-in of the force and displacement sensors (X/Y axes)
- ▶ Stipulation of measurement method and reference points
- ▶ Backup of complete unit configurations (up/download)

Measurement programs

- ▶ Creation and internal saving of 16 measuring programs. Further measurement programs can be created, saved and reloaded when required.
- ▶ Input of sets of curves
- ▶ Creation of monitoring windows and envelope curve
- ▶ Test runs with OK or NOK assessment

With the licensed full version, the production data per press-in operation can be recorded in addition.

- ▶ Production mode
- ▶ Measured data recording
- ▶ Clear-cut part reference
- ▶ Besides the programme's own format automatic print and export to ACII and Excel

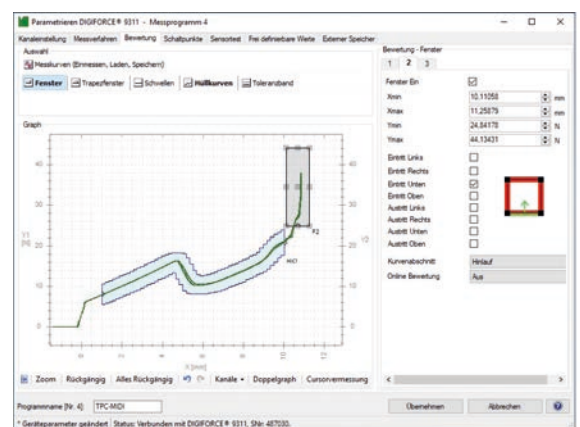
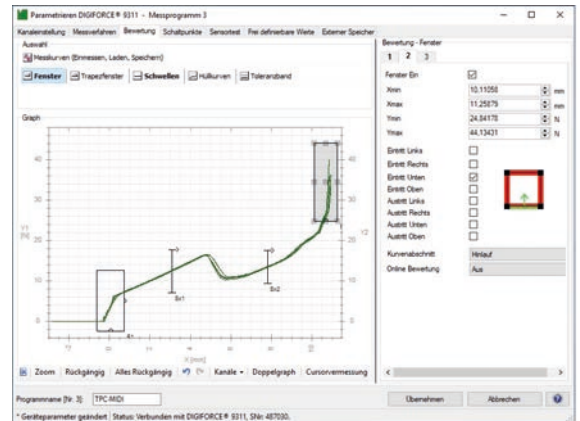

grihtoinom 22e0019 ibiM-09TTPC-Midi Process monitoring