

**BIBUS**



Mechanical Components  
Mechatronics  
Pneumatics and Process Technology  
Clamping Components  
Machines  
Environmental Technology

“Focus on our customers' success”

— Stefan van der Beek



# SUPPORT YOUR SUCCES

SERVICE & QUALITY

- **Employees of BIBUS**  
Employees of Bibus consistently think along with customers to offer solutions that address both short-term requirements and long-term goals.
- **BIBUS as a proactive partner**  
where optimal cooperation is central.

## FOUNDATION OF BIBUS

BIBUS specializes in advice and supply of technologically high-quality industrial components and solutions. From the first idea to aftercare, BIBUS products and services are used every day at all levels.

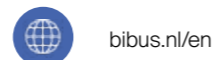
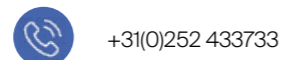
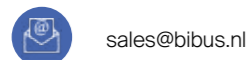

# BIBUS

# HISTORY

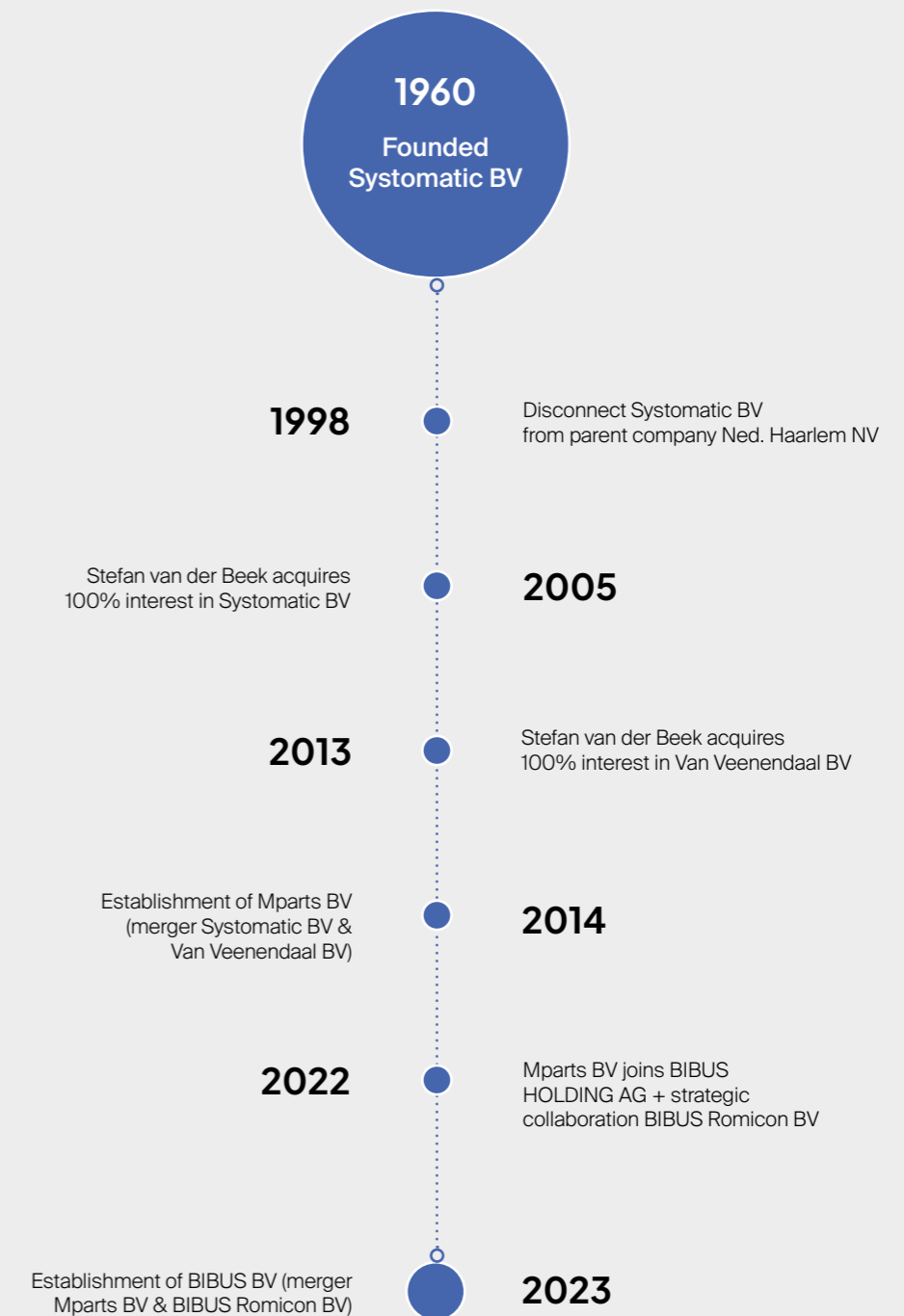

# ABOUT US

BIBUS is a successful Dutch B2B technical trading company that supplies high-quality industrial components from top foreign manufacturers to various industries, including machine and equipment builders. From the initial idea to aftercare, BIBUS products and services are utilized at all stages. The solutions offered are of excellent quality, with exceptionally extensive options.

Through years of close collaboration with clients and renowned suppliers, BIBUS has secured a permanent place in the market. The team consists of well-trained and motivated individuals with extensive practical experience and knowledge. Key aspects within the team include openness, honesty, reliability, respect, quality, and sustainability, among others. This makes BIBUS a dynamic, proactive partner where optimal cooperation is central.

“Reliability, quality and continuity always come first at BIBUS”

—— Stefan van der Beek



**PRO-ACTIVE**  
teamwork



**ADVICE**  
knowledge



**SOLVE**  
expertise



**PERSONAL**  
involved



# WHO ARE WE

- subsidiary of BIBUS Holding AG
- created by the merger between Mparts BV and BIBUS Romicon BV



**From January 1st, 2023**



**one team**



**one product assortment**



**one location**



**one name with a new look**

## The BIBUS group

A leading company in its core activities that offers its customers high-quality products and services. The key to success is the network of partners and the knowledge and experience of its employees.

## Facts and figures

BIBUS Holding AG

Founded  
1947 by Dipl. Ing. Hans Bibus

Business Units  
Technology, Materials,  
Electronics

Core Competencies  
Technics, Logistics, Services

Employees  
More than 1.100

International locations  
28 countries

Number of companies  
51 subsidiaries



# THE TEAM



“The BIBUS team has a lot of knowledge and extensive practical experience”

—— Stefan van der Beek



[sales@bibus.nl](mailto:sales@bibus.nl)



+31(0)252 433733



[bibus.nl/en](http://bibus.nl/en)

# DUAL STRATEGY

## Our strengths

BIBUS specializes in advice and supply of technologically high-quality industrial components and solutions.



### Total supplier of:

Mechanical, pneumatic and mechatronic components, process technology, environmental technology, clamping systems and machines.



**Development partner and advisor for various solutions:** cost-efficient, safe, high-quality and innovative.

Through collaboration, BIBUS can give the client a crucial advantage within the (relevant) market, by contributing ideas to the above solutions. BIBUS engineers are solution-oriented and can effortlessly advise and realize the most cost-efficient, safe, high-quality and/or innovative solutions during development phases. This ultimately results in a lower total cost of ownership.

BIBUS opts for a dual strategy. On the one hand, BIBUS focuses on knowledge regarding the product, market and application. There is an increasing need for detailed professional knowledge and good service. On the other hand, BIBUS focuses on the online webshop with more than 45,000 different components.

# ADDED VALUE

**“ Our core competencies: proactive, advice and solve“**

——— Stefan van der Beek



### Proactive and advice

technical knowledge and practical experience  
personal contact and involvement  
cost-saving advice



### Reliable and dynamic

trusted quality  
tailor-made solutions  
optimal service



### Solving and professional

strong in specials  
total supplier  
chain innovation

If one of its partners comes up with an innovation, BIBUS strives to make it known to its customers as quickly as possible. In this way, the customer can gain a significant competitive advantage. In short: joint sustainable innovation, or chain innovation, is the key to success according to BIBUS. At BIBUS, service is very important. Great value is attached to keeping agreements, because an

because an agreement is an agreement. Leading technology and offering support and service at all times are points on which BIBUS distinguishes itself in the market, an approach that is unique. BIBUS has its own workshop where minor adjustments can be made quickly.

# BIBUS & SUSTAINABILITY

## Focus for the future

At BIBUS we are proud that we are taking another step towards a greener and more sustainable future! Sustainability is of paramount importance within BIBUS BV, which is why the roof is now equipped with solar panels. Generating 100% green energy is the next step in BIBUS' sustainability policy. Is the work done now? Certainly not, it's just starting now! We remain committed to better performance in the areas of environment, sustainability, safety and health.



ON BEHALF  
OF THE **BIBUS**  
GROUP

It is our responsibility to consider the impact we have on the environment and take proactive steps to address and minimize it.



[sales@bibus.nl](mailto:sales@bibus.nl)









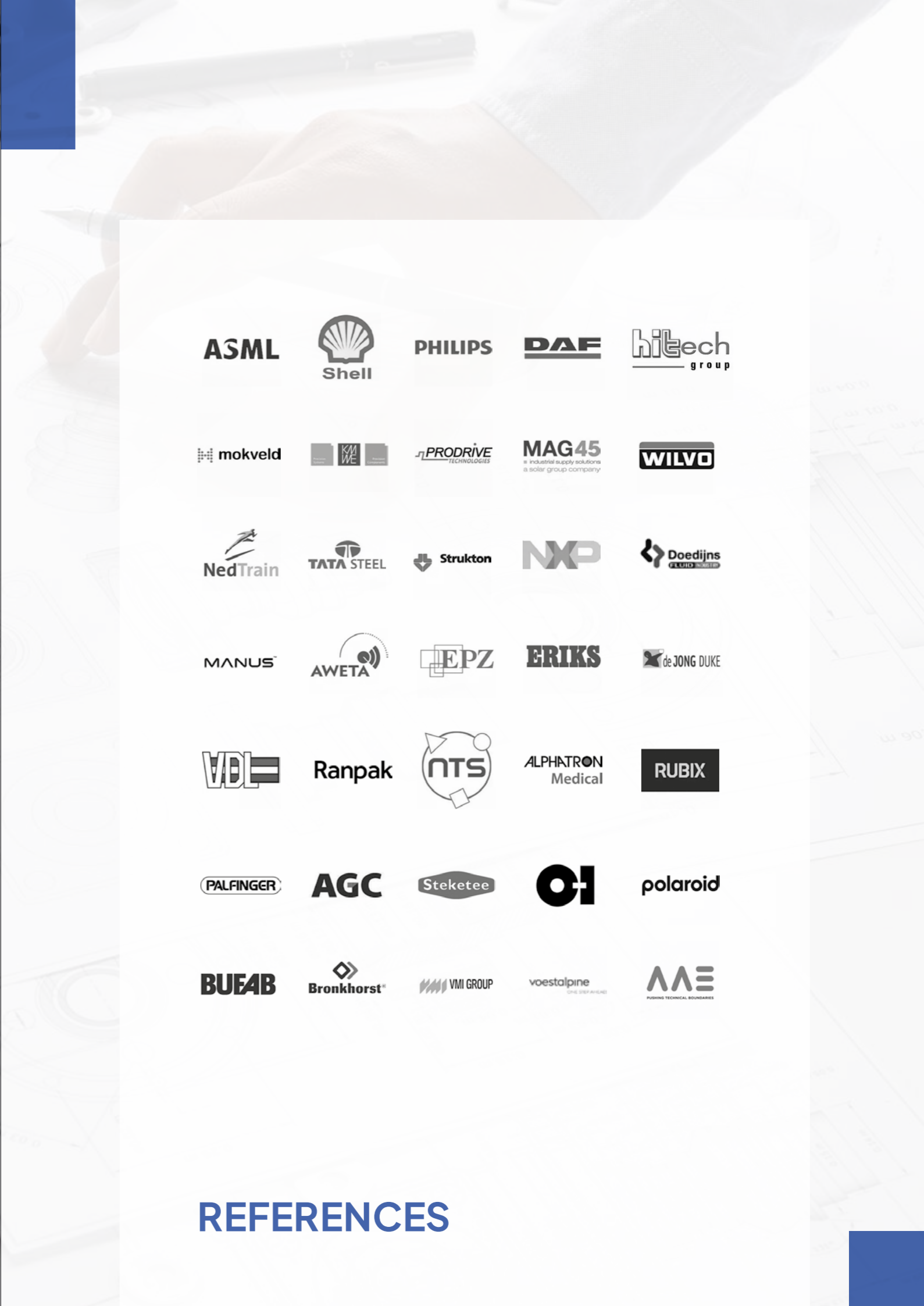
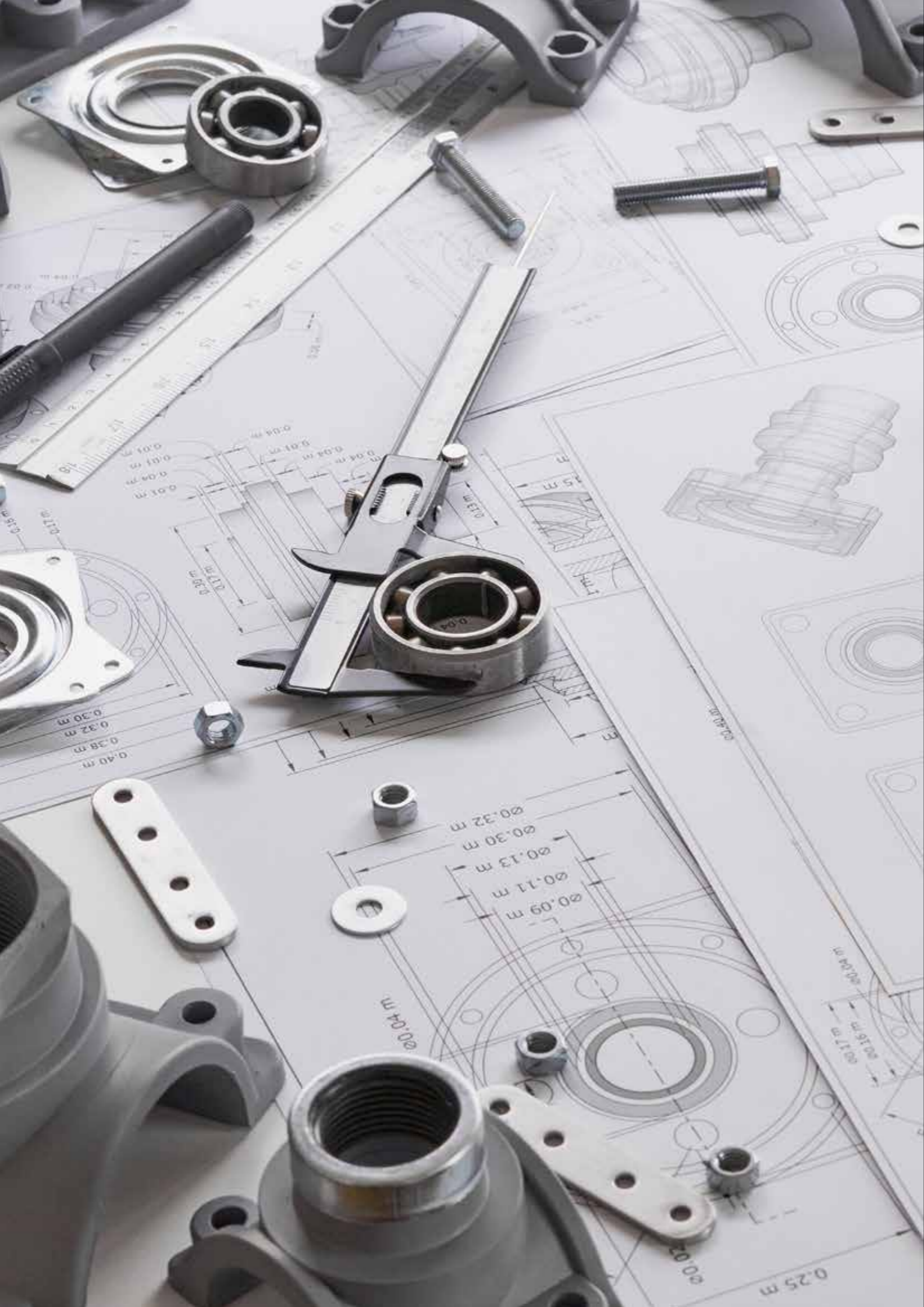











+31(0)252 433733



[bibus.nl/en](http://bibus.nl/en)



- |   |  |  |  |   |
|---|--|--|--|---|
| <b>ASML</b>   | <br>Shell     | <b>PHILIPS</b>   | <b>DAF</b>   | <b>hitech</b><br>group  |
|  mokveld     |               |  PRODRIVE<br>TECHNOLOGIES | <b>MAG45</b><br>Industrial supply solutions<br>a solar group company                     | <b>WILVO</b>  |
|  NedTrain    |  TATA STEEL   |  Strukton                 | <b>NXP</b>   |  Doedijns<br>TECHNOLOGIES              |
| <b>MANUS</b>  |  AWETA      |  EPZ                    | <b>ERIKS</b>   |  de JONG DUKE                        |
| <b>VDE</b>  | <b>Ranpak</b>  |  NTS                    | <b>ALPHATRON</b><br>Medical  | <b>RUBIX</b>  |
|  PALFINGER | <b>AGC</b>   |  Steketee               |  OI | <b>polaroid</b>   |
| <b>BUFAB</b>  |  Bronkhorst |  VMI GROUP              | <b>voestalpine</b><br>ONE STRATEGY   |  A&E<br>PUSHING TECHNICAL BOUNDARIES |

## REFERENCES



## PARTNERS

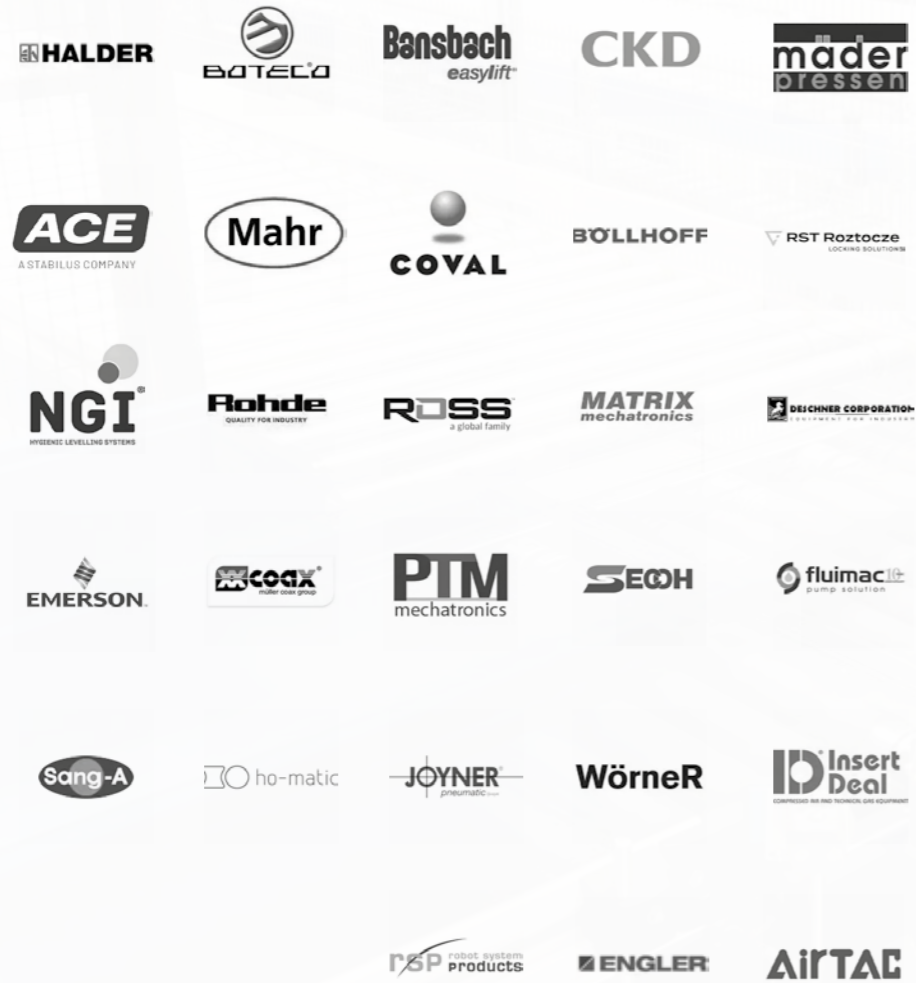

## UNIQUE SELLING POINTS

- continuity & innovative
- one-stop-shop
- A-brands & cross-selling strategy
- extensive product range
- high-quality components
- experience and knowledge of product/market combinations

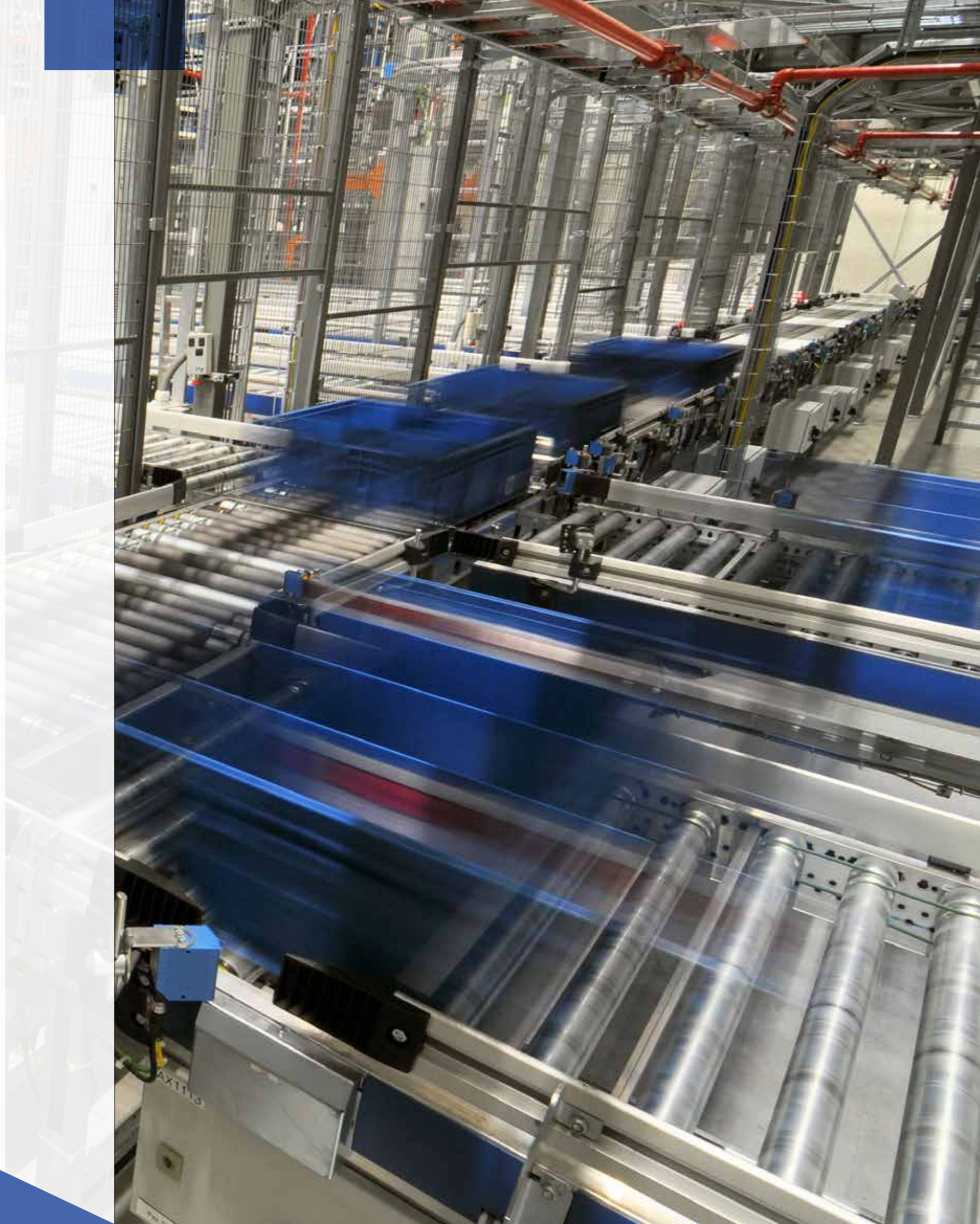

# BIBUS ONLINE

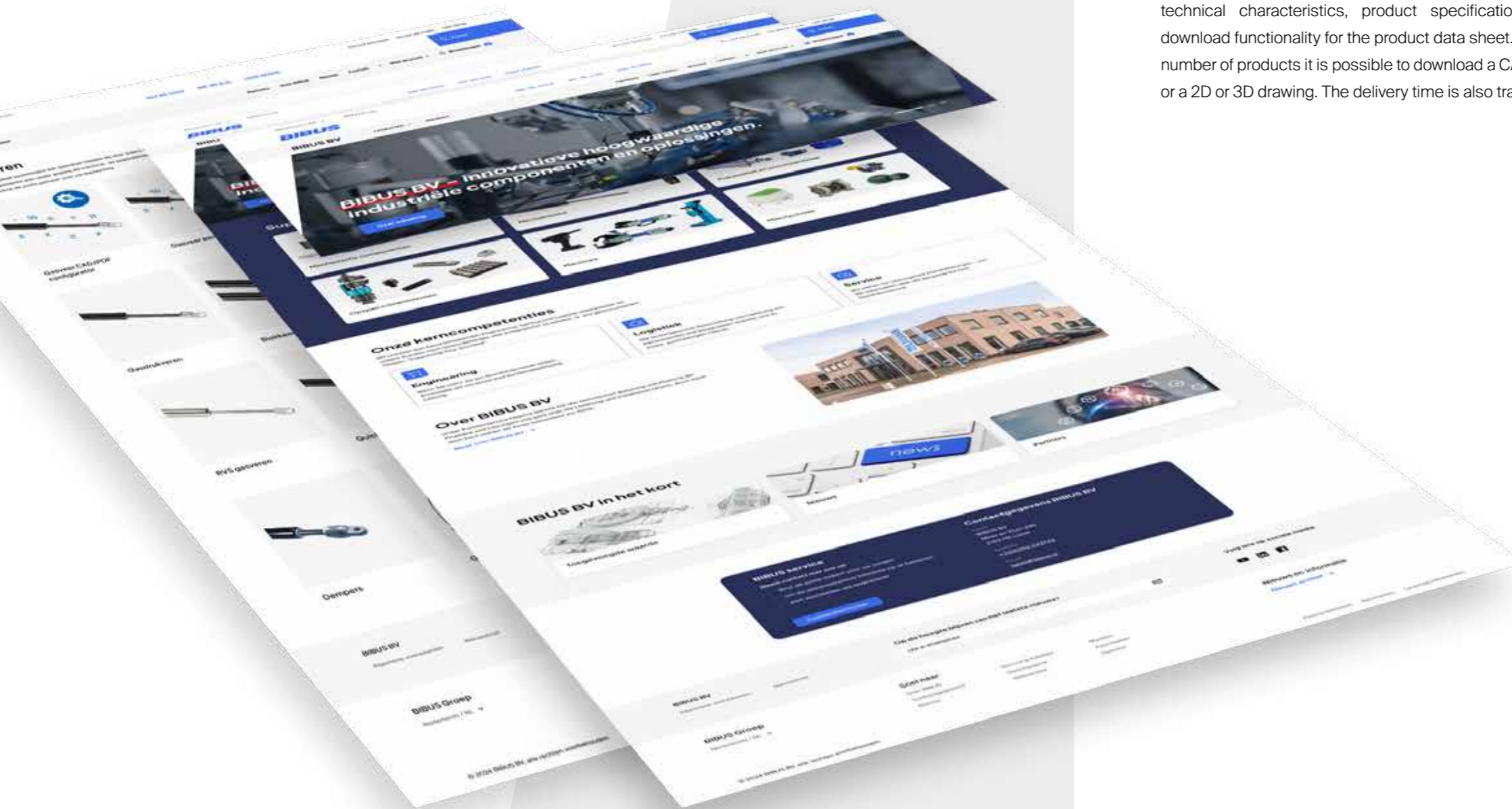

The BIBUS website provides access to the webshop with no fewer than 45,000 components. Products ranging from spacers, locking bolts, hinges, pneumatics and process technology to an extensive range of gas springs and actuators. Customers have many benefits including: ordering 24/7, viewing order history, no minimum order value, customer-specific discounts and lower order and shipping costs.

The website can be searched easily by color, material, type of product, BIBUS or supplier code. The product you are looking for is in all cases shown with a photo, dimensional drawing, technical characteristics, product specifications and a download functionality for the product data sheet. For a large number of products it is possible to download a CAD file and/or a 2D or 3D drawing. The delivery time is also transparent.



## 2D - 3D files

- download quickly and easily
- configure CAD files yourself
- create the actuator/gas spring yourself



## Wide range online

- up-to-date and practical product information
- insight into delivery times and conditions
- lower order and shipping costs



## Order 24/7

- knowledge at your fingertips
- request samples
- extensive search functions

## BENEFITS ONLINE ORDERING

Order online with a wide range to choose from, easy comparison, detailed information, fast delivery and various CAD configurators. It is a convenient and efficient way to find the right components and successfully carry out your projects.



# MARKETING & COMMUNICATION

## Online & Offline

- website NL & ENG
- newsletters: monthly, informative, innovations
- social media: LinkedIn, Facebook, Youtube
- technical articles & press releases
- exhibitions
- documentation by the website:  
real-time printing from SAP-database



# DOCUMENTATION NL & ENG

## Direct & Up-to-date

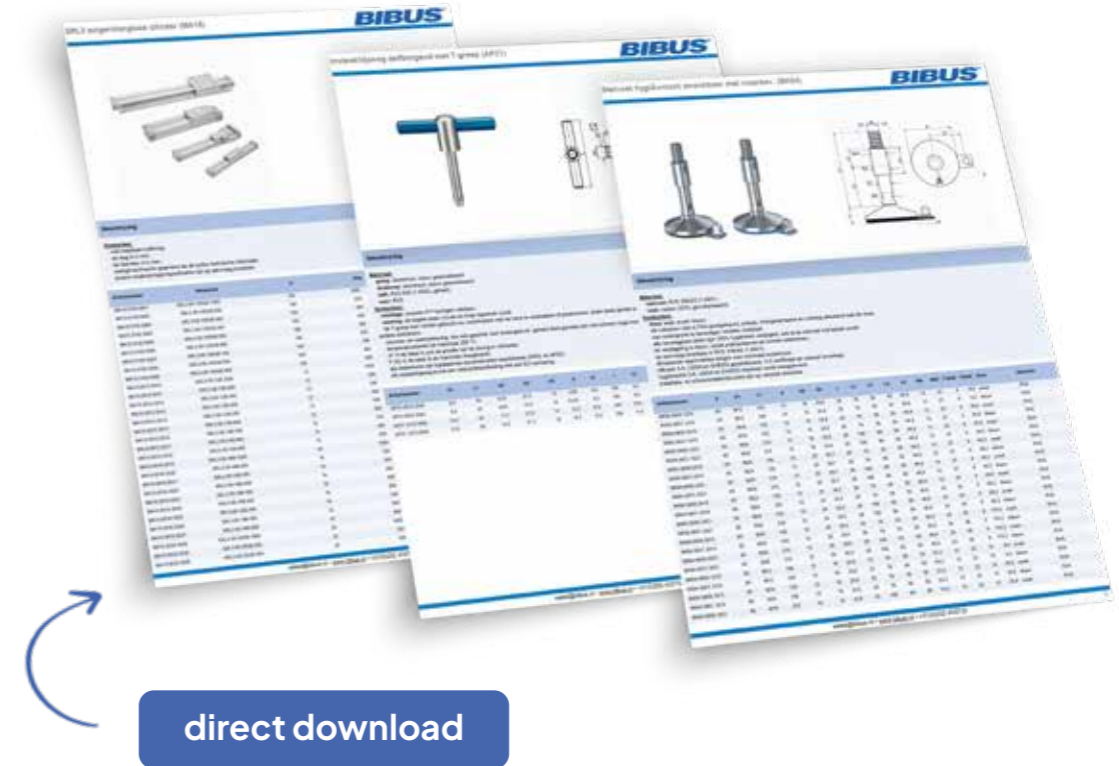

## SOCIAL MEDIA

Follow BIBUS on LinkedIn for updates about new products and interesting articles.

Also visit our YouTube channel for many informative videos of our components.





## THE ASSORTIMENT

BIBUS is a total supplier in the field of:

- mechanical components
- mechatronics
- pneumatics and process technology
- clamping components
- machines
- environmental technology



## MECHANICAL COMPONENTS

- operate
- machine elements
- fasten
- cable management
- protect
- robot accessories

lifting pins	index plungers	knobs with female thread	knobs with threaded end	knobs with bore	clamping levers	U-handles	SST 316L handles	grips	crank handles
levers	handwheels	swing handles	locking systems	locks, keys and latches	cams, rods and guides	catches			
spring plungers	thrust screws	levelling feet	ball casters	elements	toggle latches	internal hinges	external hinges	magnets	wheels
spacers	PCB-supports	PCB-rails	push rivets	blind rivets	blind rivet nuts	screw and bolts	nuts	rings	cable ties
grommets	heat shrinking tubing	cable clamps	caps	shoulder washers	gaskets	tool systems	tool changers	swivels	swivel tool changers
CIRO	hose packages	components and accessories							



## MECHATRONICS

- motion
- damping technology



## PNEUMATICS AND PROCESS TECHNOLOGY

- pneumatics
- process technology
- vacuum technology
- measuring and control technology



sales@bibus.nl



+31(0)252 433733



bibus.nl/en

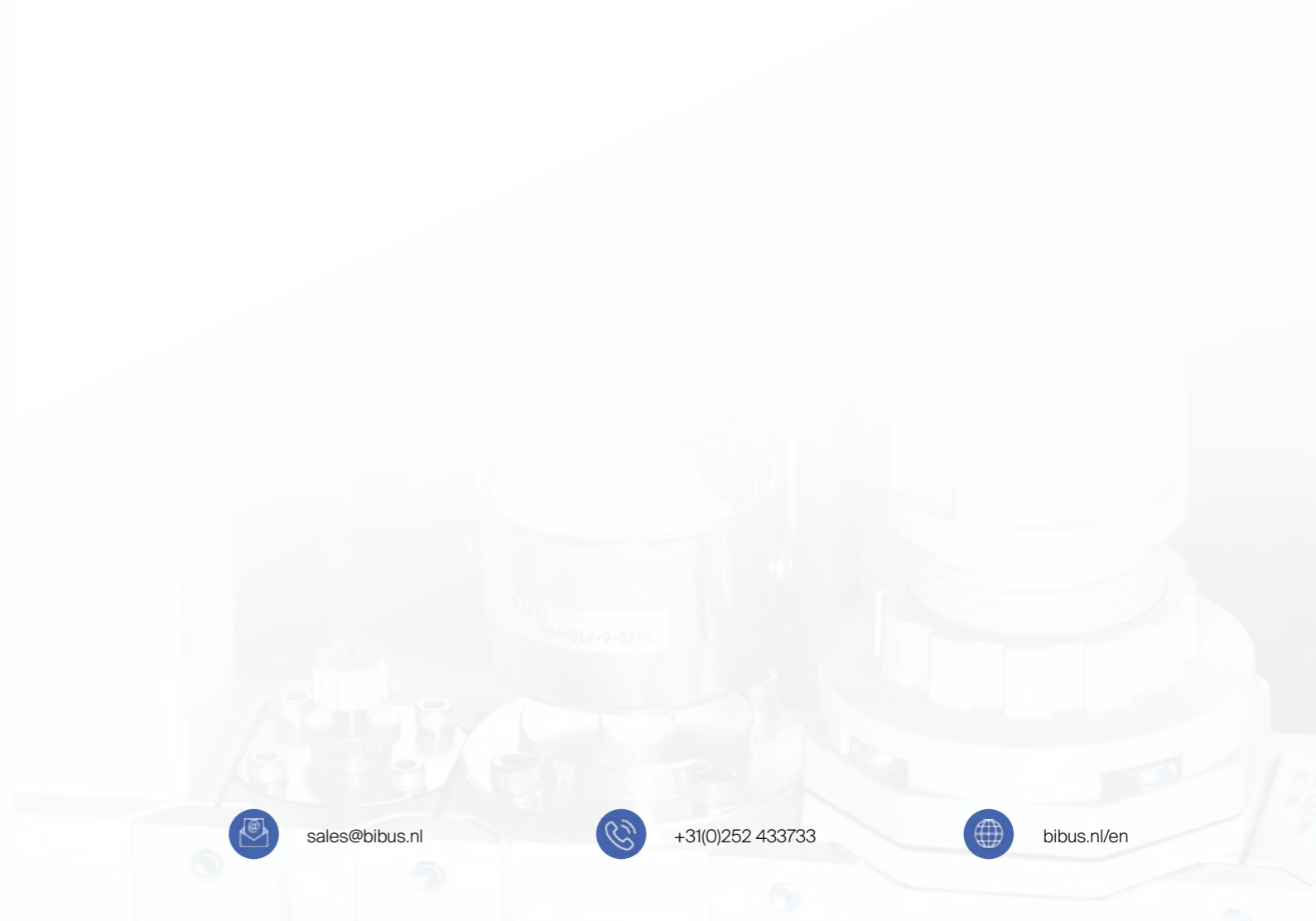

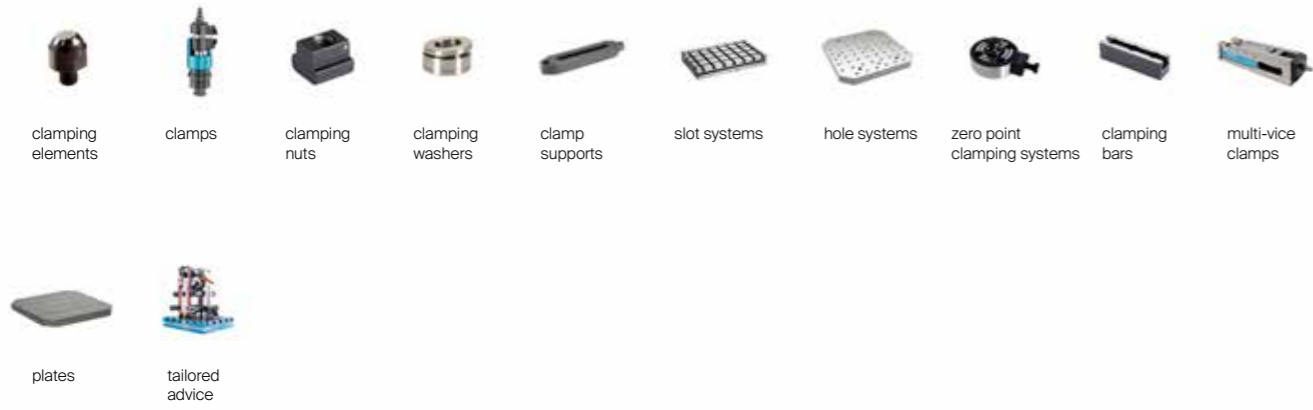

## CLAMPING COMPONENTS

BIBUS supplies a wide range of clamping components, ranging from clamping elements to complete clamping systems.



sales@bibus.nl



+31(0)252 433733



bibus.nl/en





## MACHINES

BIBUS not only supplies high-quality technical components for machine and equipment builders, but also plug & play machines. The website distinguishes between three types of machines: **industrial presses, clinch machines and blind rivet tools.**



air pumps



membrane diffusers



side channel blowers



diaphragm pumps

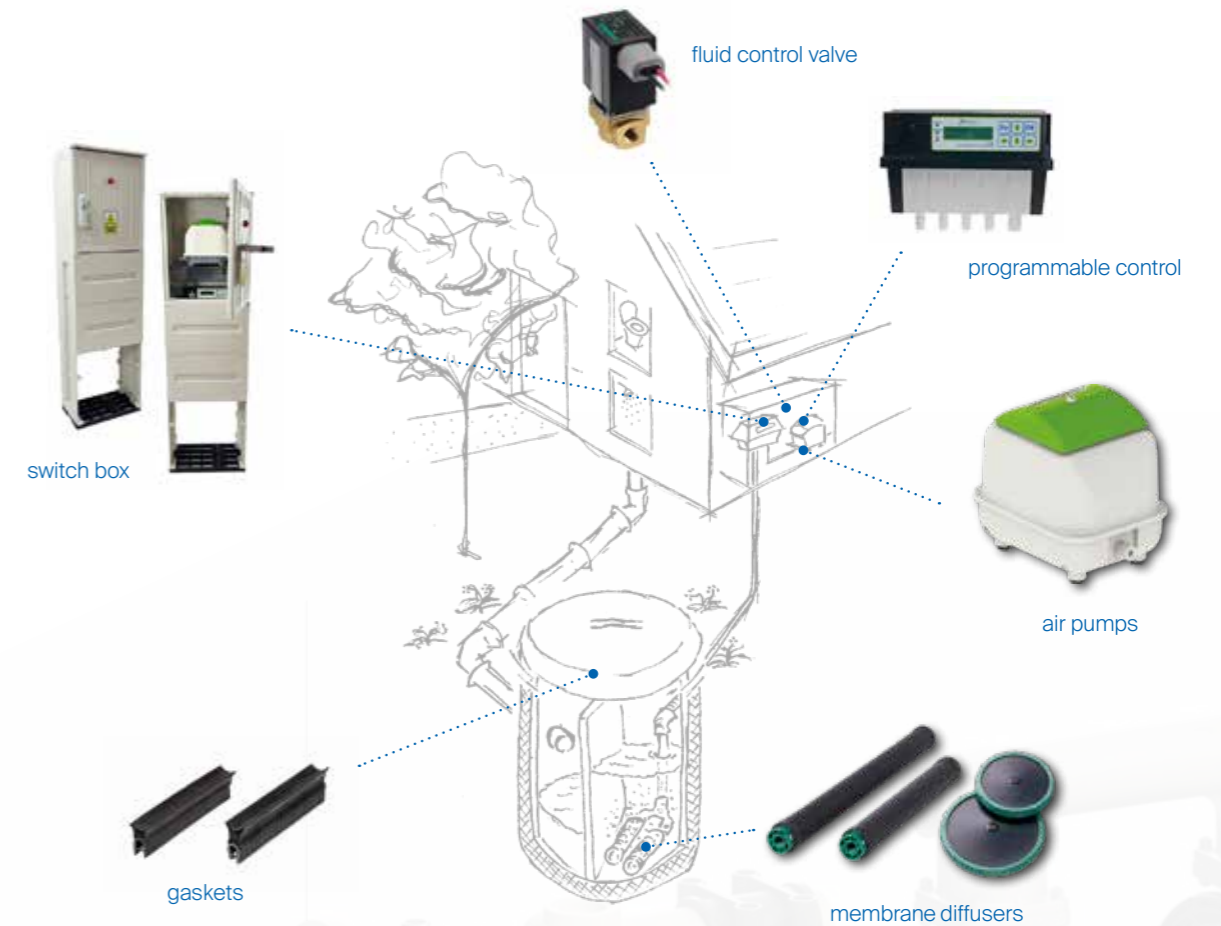

## ENVIRONMENTAL PUMPS

- air pumps
- membrane diffusers
- side channel blowers
- diaphragm pumps

# INDUSTRY

Production

Man

Services

St

Development

Engineering

## YOUR MARKET, OUR KNOWLEDGE



Machine and equipment building



Sports



Healthcare



Packaging



HVAC



Furniture



Outdoor living



Transport



Food



Agricultural



Marine



Semiconductor



sales@bibus.nl



+31(0)252 433733



bibus.nl/en

# BIBUS IN PRACTICE

## Our solutions

Because BIBUS has been active in the Benelux manufacturing industry since 1960, the team of well-trained and motivated people has a lot of knowledge and extensive practical experience. Please view here an impression of various product applications in different markets.

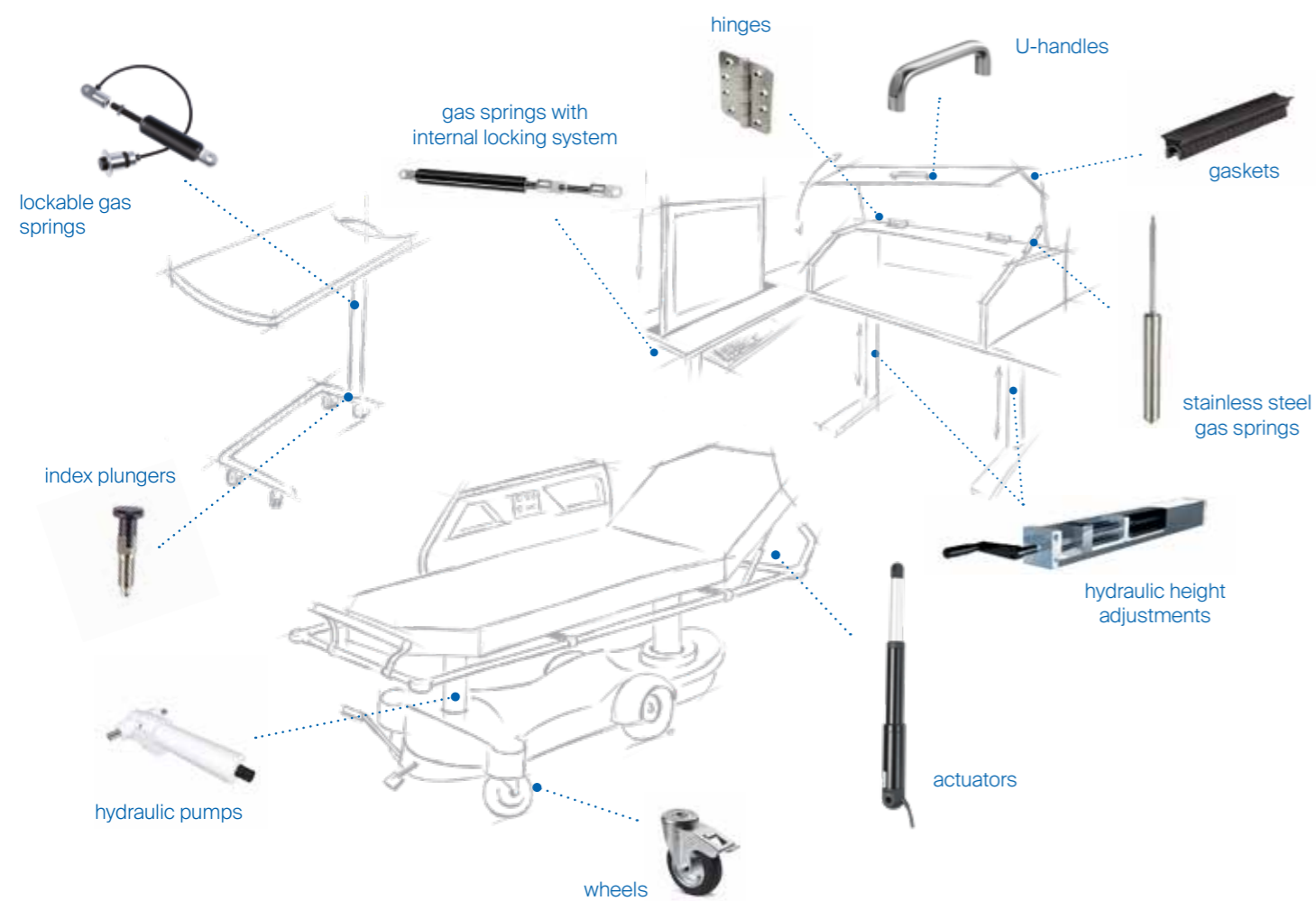

### EXAMPLE PRODUCT APPLICATION

In modern machines, numerous products are used to perform a wide range of functions. Whether it concerns industrial equipment, consumer electronics, agricultural machinery or vehicles, components in machines play an essential role in their functioning.

# BIBUS IN PRACTICE

“BIBUS: your partner in industrial automation”

# INNOVATIVE & PRO-ACTIVE

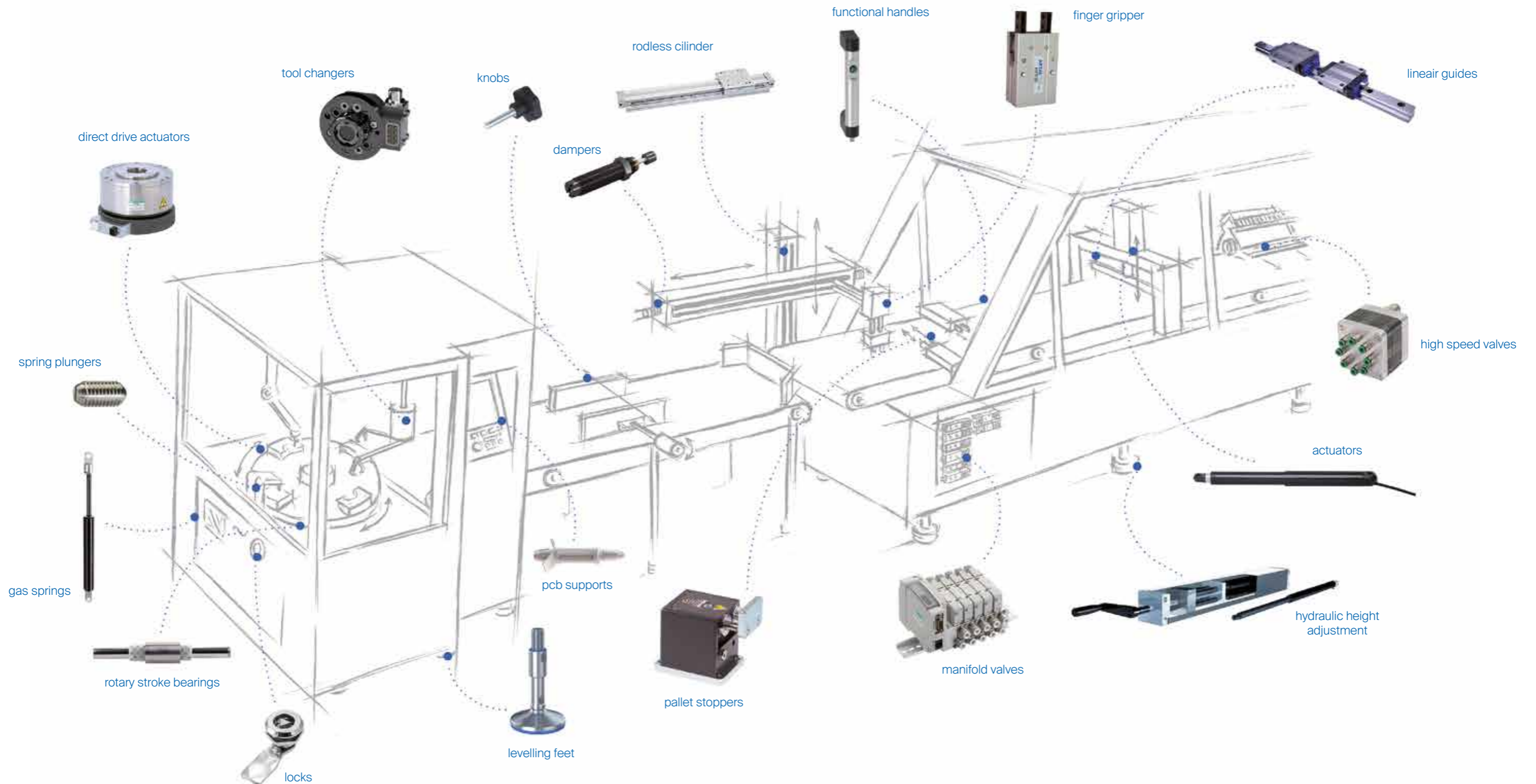



**BIBUS B.V. Netherlands**  
Meer en Duin 295  
2163 HE Lisse

Tel: +31(0)252 433733

[sales@bibus.nl](mailto:sales@bibus.nl)  
[www.bibus.nl/en](http://www.bibus.nl/en)

