

TS

Level Compensators



TS series compensated spring systems are recommended for horizontal handling of parts at different levels. The spring function also ensures that the gripping points are applied on the same plane when gripping with multiple suction cups.

Materials

- Spring** Stainless steel
- Tubing** Zinc-plated steel
- Slider** Brass

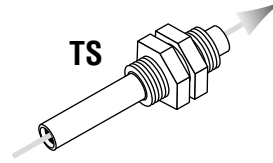

Characteristics

Models	TS1				TS2				TS3				TS1.20 LG
Stroke	05	10	20	30	10	30	50	70	10	30	50	70	20
L	29	39	59	79	48	88	128	168	48	88	128	168	59
Spring force (N/mm)	0.36	0.15	0.07	0.045	0.9	0.2	0.115	0.08	0.9	0.2	0.115	0.08	0.07
Force at rest (N)	1.00	1.70	1.45	2	8.1	4.2	4.5	4.5	5.1	4.2	4.5	4.5	1.45

Note: All dimensions are in mm

4
TS

TS1 TS2 TS3 TS1.20 LG

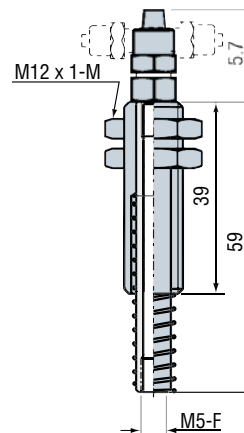
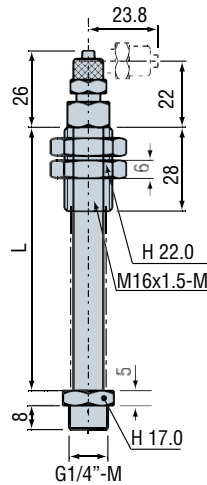
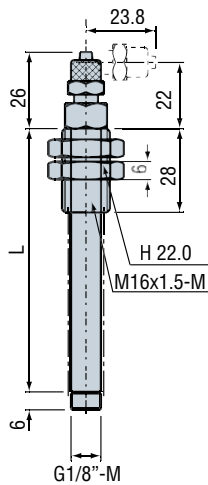
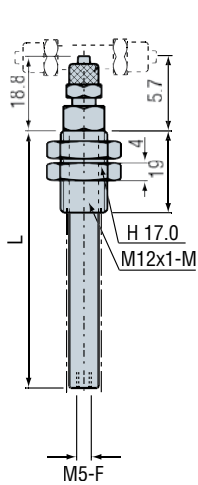

Please specify the part n° e.g.:
Model + Spring stroke + Fitting
 e.g.: **TS350C46**

1: Model	2: Spring stroke	3: Fittings (for TS series)
TS1	05 - 10 - 20 - 30 (TS1)	D46 (Straight 4 x 6 - TS1, TS2, TS3)
TS2	10 - 30 - 50 - 70 (TS2, TS3)	D68 (Straight 6 x 8 - TS2, TS3)
TS3		C46 (Elbow 4 x 6 - TS1, TS2, TS3)
		C68 (Elbow 6 x 8 - TS2, TS3)
		T46 ¹ (T-shape 4 x 6 - TS1)
		N ² (Without fitting)

Advantage of the TS120LG
 The adjustment height is twice that of the standard TS1 spring system and its spring is protected.

(1) versions T46 and T68 on request for TS2 and TS3.
 (2) For TS1 model, vacuum connection M5-F and for models TS2 and TS3 vacuum connection G1/8"-M.

TS

Level Compensators



Characteristics

Models	TS4 50	TS5 60
Stroke	45	60
L	196	234
Spring force (N/mm)	0.47	1.23
Force at rest (N)	4	0

Materials

Spring Stainless steel
Tube Zinc-plated steel
Slider Brass

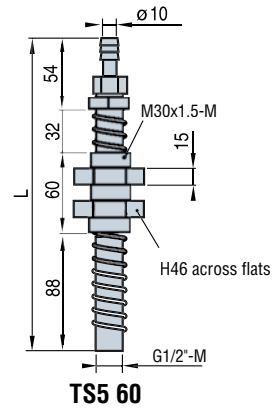
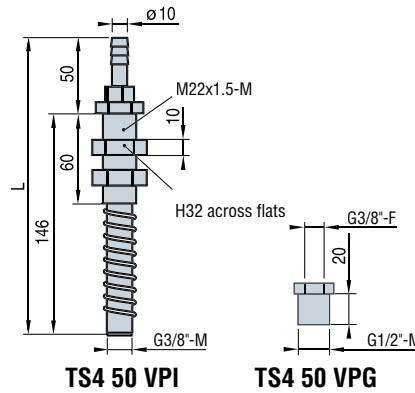

Note: All dimensions are in mm

4 RSC

Multi-Compensator Systems

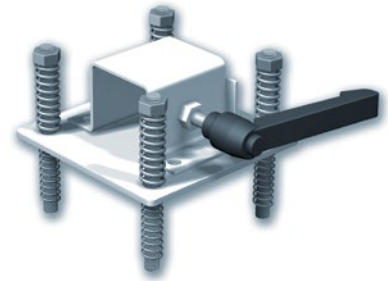

Use

The system of 4 compensated springs is particularly recommended for horizontal handling requiring large diameter suction cups. The upper stainless steel springs act as dampers for all vertical movements. They compensate for different levels between the suction cups. The system of 4 compensated springs mounted in a square gives the assembly a ball-joint effect.

Materials

Spring Stainless steel
Damper Stainless steel
Studs A 60
Colour Yellow RAL 1023

Characteristics

Models	Max. load (N)	Stroke under traction	Vertical force (N)	Maxi. weight (kg)	Ball-joint angle	Tube mounted	A	B	C	D	E	F	G	H	I	J	K	L
RSC1	2000	30	160	1	10°	50	140	106	88	50	M8-F	M10-M	8	120	5	52	52	9
RSC2	4000	30	340	2.7	10°	80	190	150	120	70	M12-F	M14-M	8	130	8	83	83	13

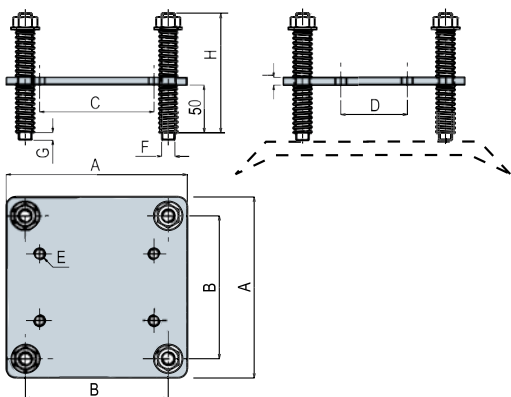

RSC option...VAC

Square tube mounting options (Tightening by indexable lever).

- RSC1 VAC on 50 mm square tube.
- RSC2 VAC on 80 mm square tube.

Note: All dimensions are in mm

Note:

- RSC1: for SPL 240 suction cups, 5085 steel suction cups, VA 250, VA 280 and VA 320.
- RSC2: for SPL 340 suction cups, 5150 steel suction cups, VA 350, VA 380 and VA 410.



Please specify the part:
Model + Type + Tube mounting option
 e.g.: RSC2VAC

1: Model	2: Type	3: Tube-mounting option
RSC	1	max. 2000 N
	2	max. 4000 N
	VAC	with tube-mounting option