

Wörner

Stopping and positioning modules for automation technology

Product overview – 2022

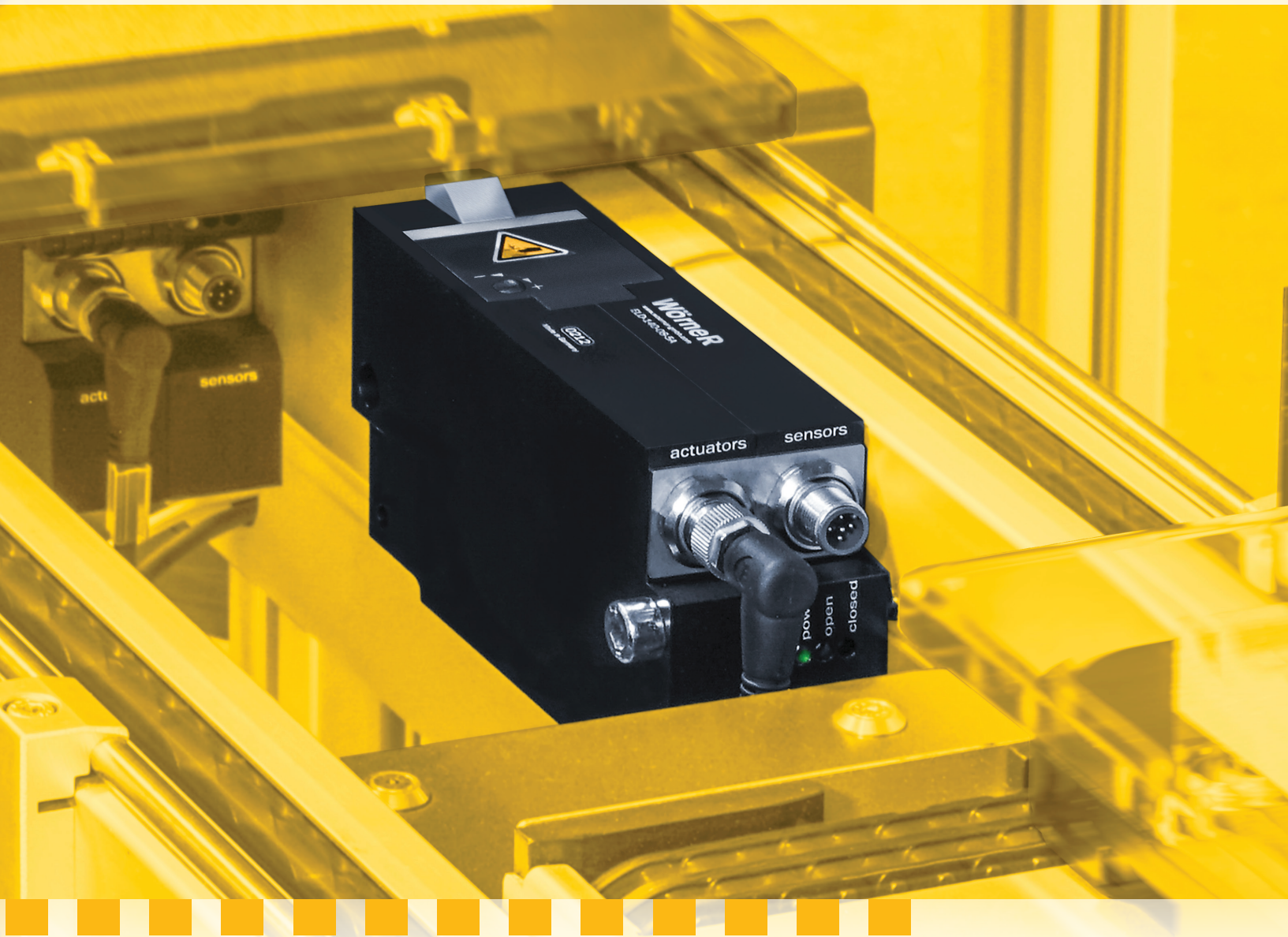

Der Wörner-Stopper. Das Original.

Electric stoppers for every requirement

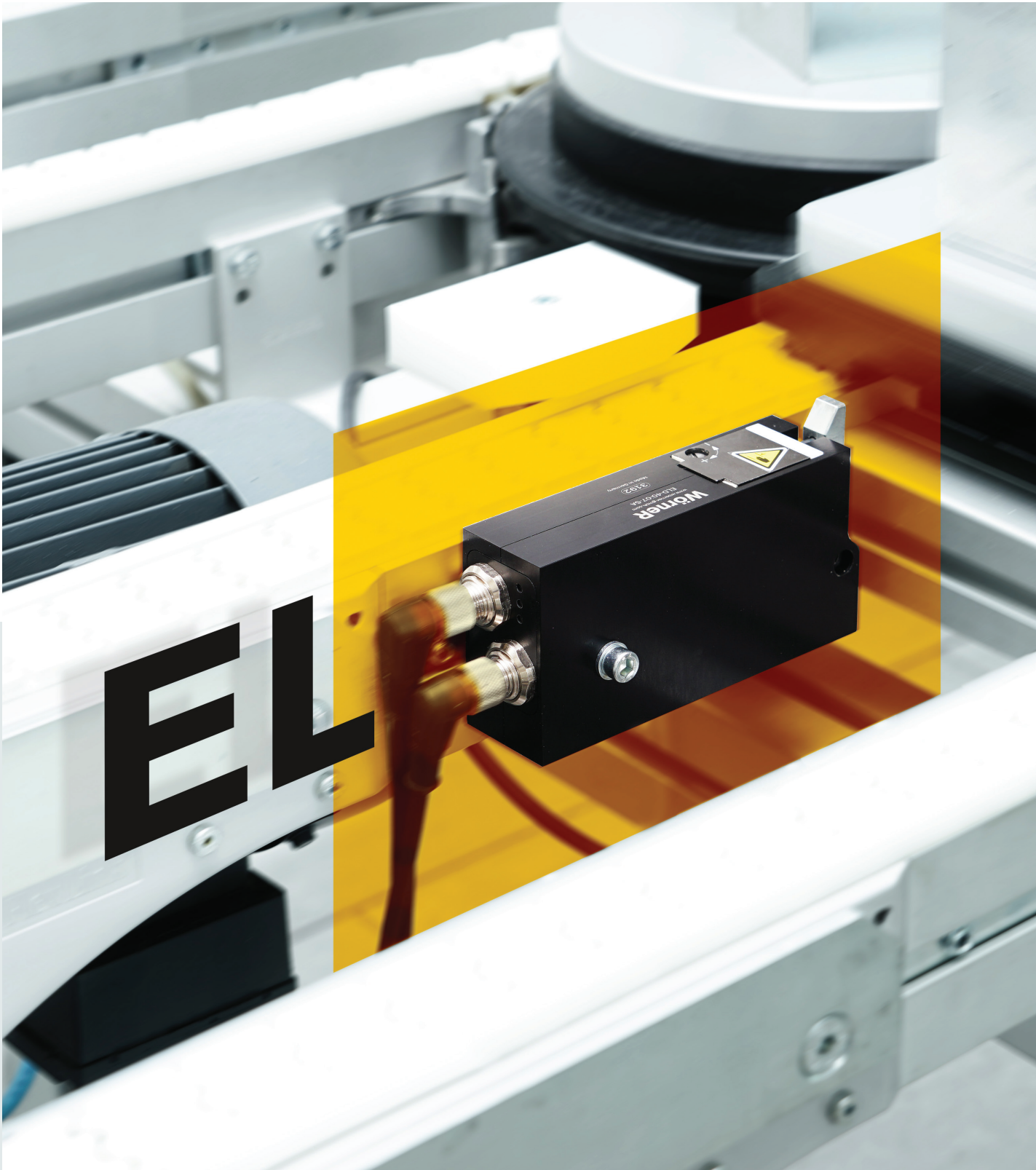

EL

Extensive product family: Electric stoppers with highest efficiency

Electrically driven stoppers provide numerous advantages:

- more than 70 % higher efficiency (compared to pneumatic systems)
- low operating costs
- minimal installation expenditure
- integrated sensors
- simple control of material flow
- low noise

Wörner electric stoppers are engineered to meet the requirements of a vast range of industries, with a proven track record in countless industrial automation applications.

Transport speed, pallet weight and robustness parameters determine the selection of the suitable Wörner component.

 You will find the stoppers of the proven ELD line starting on page 18.

Electric stoppers in a new variety



ELD-40



ELD-140

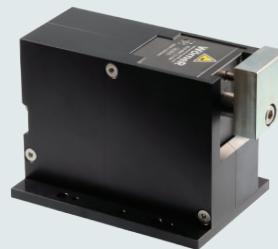

ELD-660



ELD-70



ELD-195



ELD-430

Damping, stopping, positioning: The right solution for every requirement

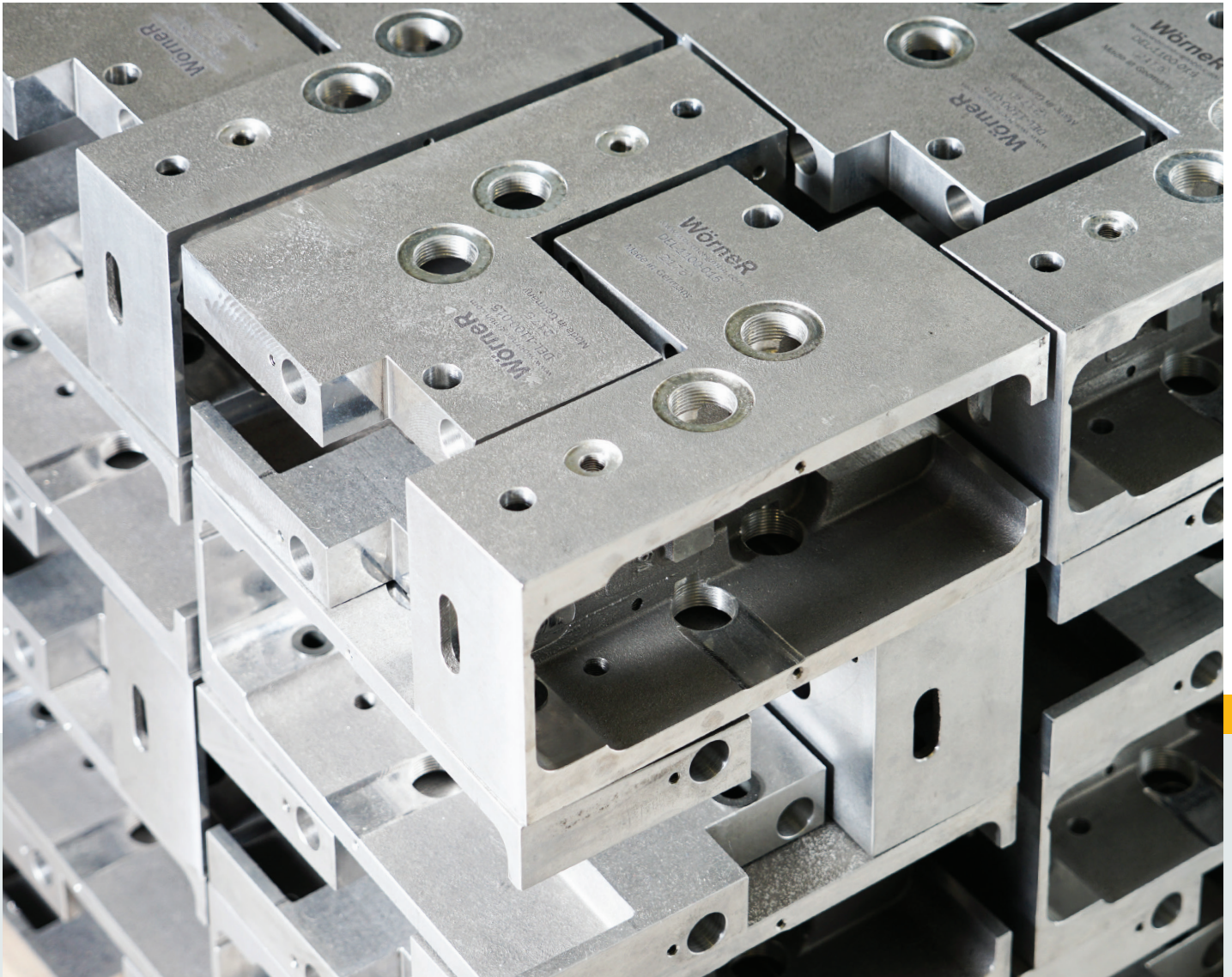

From a simple workshop ...

The success story of our stoppers is based on the brilliant idea of the creative mind Helmut Wörner. The technology was patented in Germany 1990, from there the triumph takes its course: Within Europe and soon also internationally.

Today, Wörner stoppers are well-known around the globe. They are in fact a synonym for precision, durability and a safe investment.

*The first industrial stopper, the
Wörner Delta „SDEH-5000“ (1986)*



... to an international specialist for leading-edge stoppers

Wörner's product portfolio covers more than 2.500 components: stoppers, angle dampers, index cylinders and anti-bounce stops are successfully applied in all conventional assembly and conveyor systems in a large variety of industrial sectors.

Experience grown over decades, excellent industry know-how and a modern, highly specialized machine park guarantee that even unusual customer demands can be satisfied.

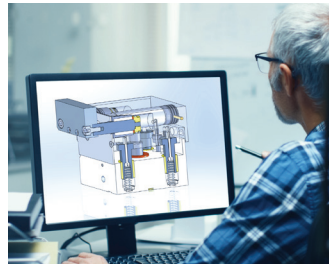

New, custom solutions through close collaboration

We welcome the chance to put our skills to the test with special tasks: The Wörner expert team generates solutions for any requirement – either from the existing product range of standard products or by designing a tailor-made solution in close cooperation with the customer.



Uncompromising quality and performance

Wörner products “Made in Germany” ...

Wörner has always been committed to an effective quality management system.

The entire Wörner staff is dedicated to achieve our most important goals: providing top performance for the highest quality of all products and services, achieving greatest customer satisfaction and ensuring competitiveness.

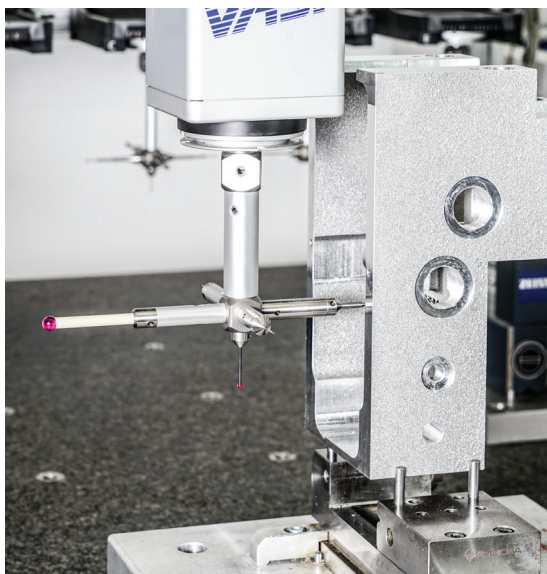

Component coordinate-measuring

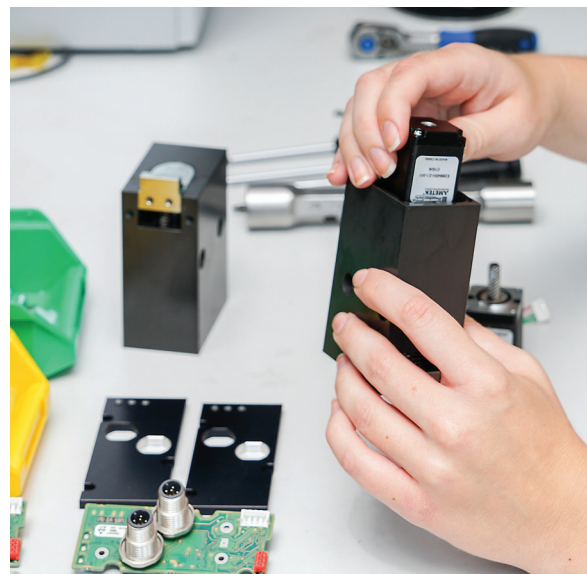

Electrical stopper assembly

Wörner components for automated assembly, handling and manufacturing

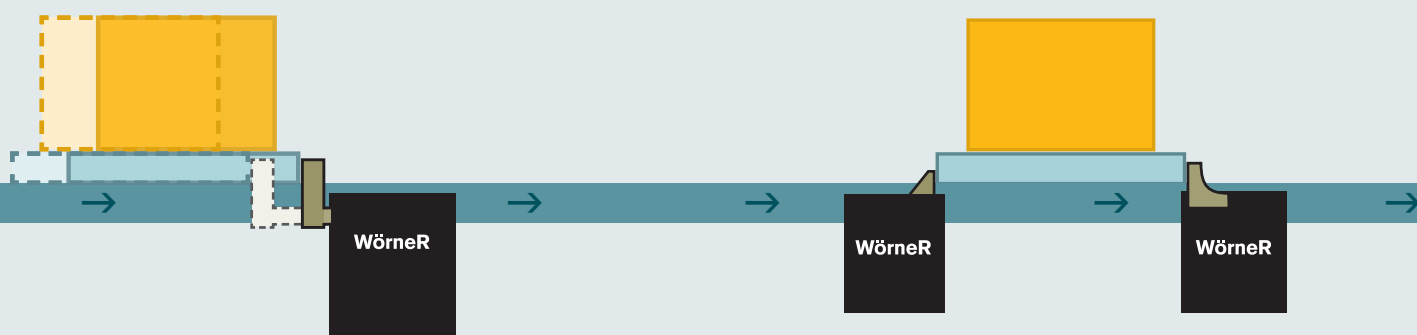

Damped stoppers

For shock-sensitive, fragile parts. Pallets are gently decelerated as they arrive so that workpieces reach their final position without rebound.

Anti-bounce stops

Anti-bounce stops hold the pallet loaded with individual parts in position with absolute precision to prevent any rebound.

Undamped stoppers

The tough, economical basic design. Suitable for use wherever one or more pallets are to be accumulated at a defined position.

... successfully applied all over the world

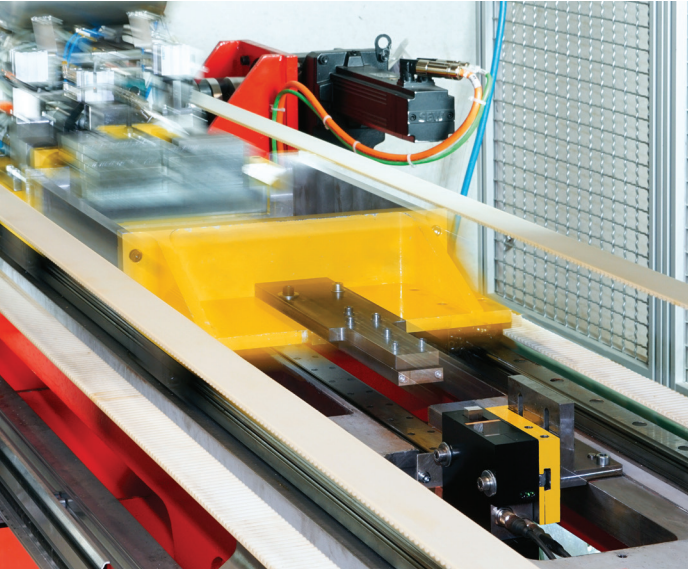

Endurance testing

Wörner's quality and environmental management systems are successfully certified in accordance to the international standards DIN ISO 9001 and ISO 14001. When developing new products, they have to pass extensive endurance tests.



Packaging and shipping

After assembly, every single unit goes through a final inspection.

Before any component leaves the factory, it is carefully packed. Through the international distribution network, Wörner products and services are available world wide.

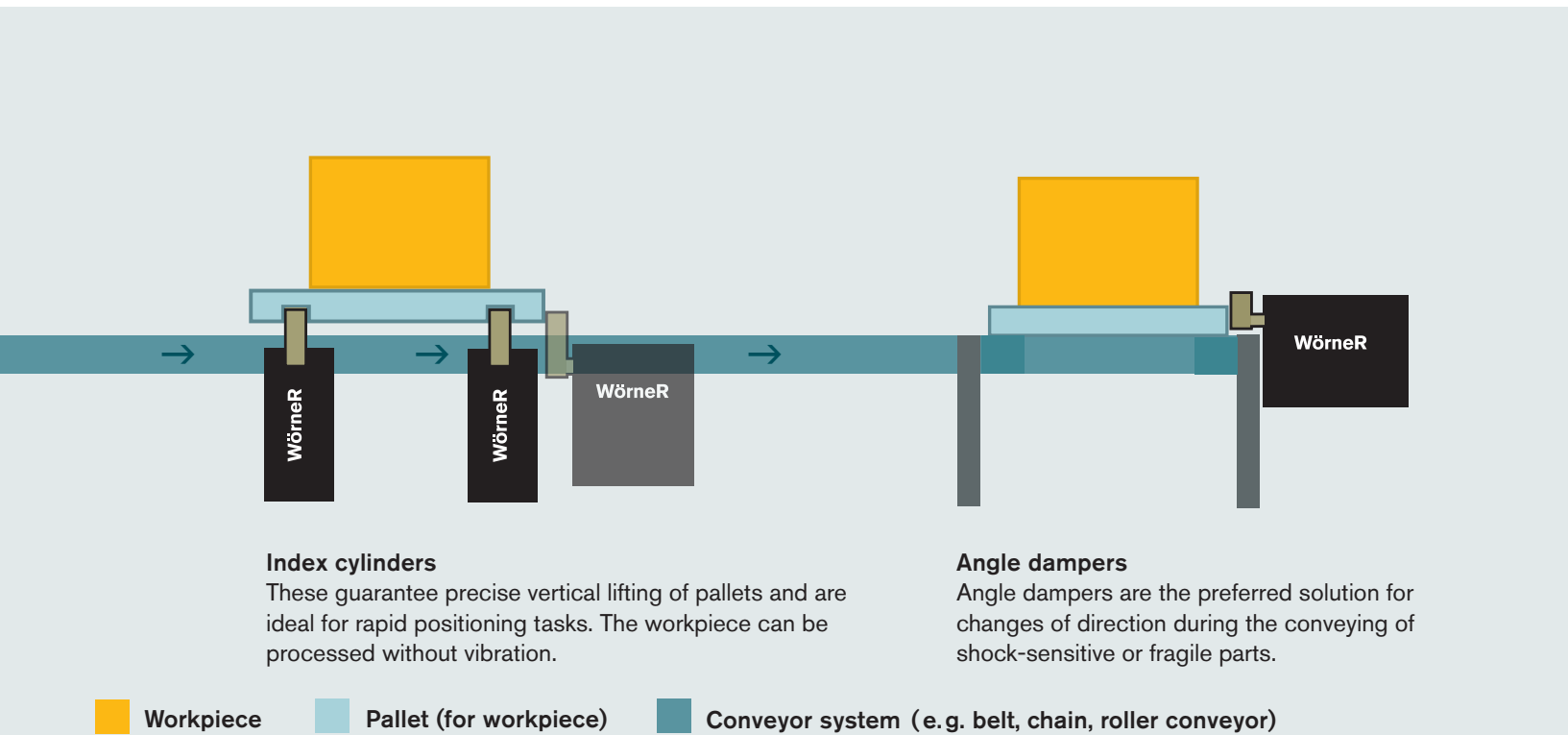



Product group

Page

Pneumatic undamped stoppers	D0 / PNU	10
Pneumatic damped stoppers	DBS / PND	13
Electric undamped stoppers	DEL0 / ELU	18
Electric damped stoppers	DEL / ELD	19
Pneumatic damped stoppers for roller systems	DBSR	22
Accelleration Units	DAU	24
Displacement Stops	DDU/DDS	25
Pneumatic /electric angle dampers	DBSQ/ELDQ	26
Pneumatic index cylinders	DI / DIA	28
Pneumatic /electric anti-bounce stops	DR / DRP / DRE	29

Anti-bounce stops

	Basic product	Stroke	Variants
	DR	8 mm	cust.-spec. solutions var. access.
	DRP	8 mm	I/E EA ST cust.-spec. solutions var. access.
	DRE	9 mm	cust.-spec. solutions var. access.

H heat-resistant
I prepared for inductive position sensor
E prepared for electronic position sensor

U universally, can be used for all types of conveyor profiles
EA electronic sensor at stop
ST Stopper

Custom-built:

DRP-001

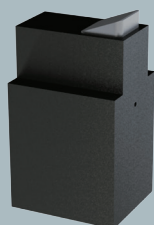

This unit possesses a different housing geometry: increased height, recesses at the side, and threaded holes at the bottom of the case to permit fastening from below.

Accessories

Product-specific accessories

We offer an extensive range of accessories to accompany our products. For details, please refer to the relevant data sheets.

By way of example, the accessories illustrated here are for the pneumatically driven, damped stopper DBS-20/60:

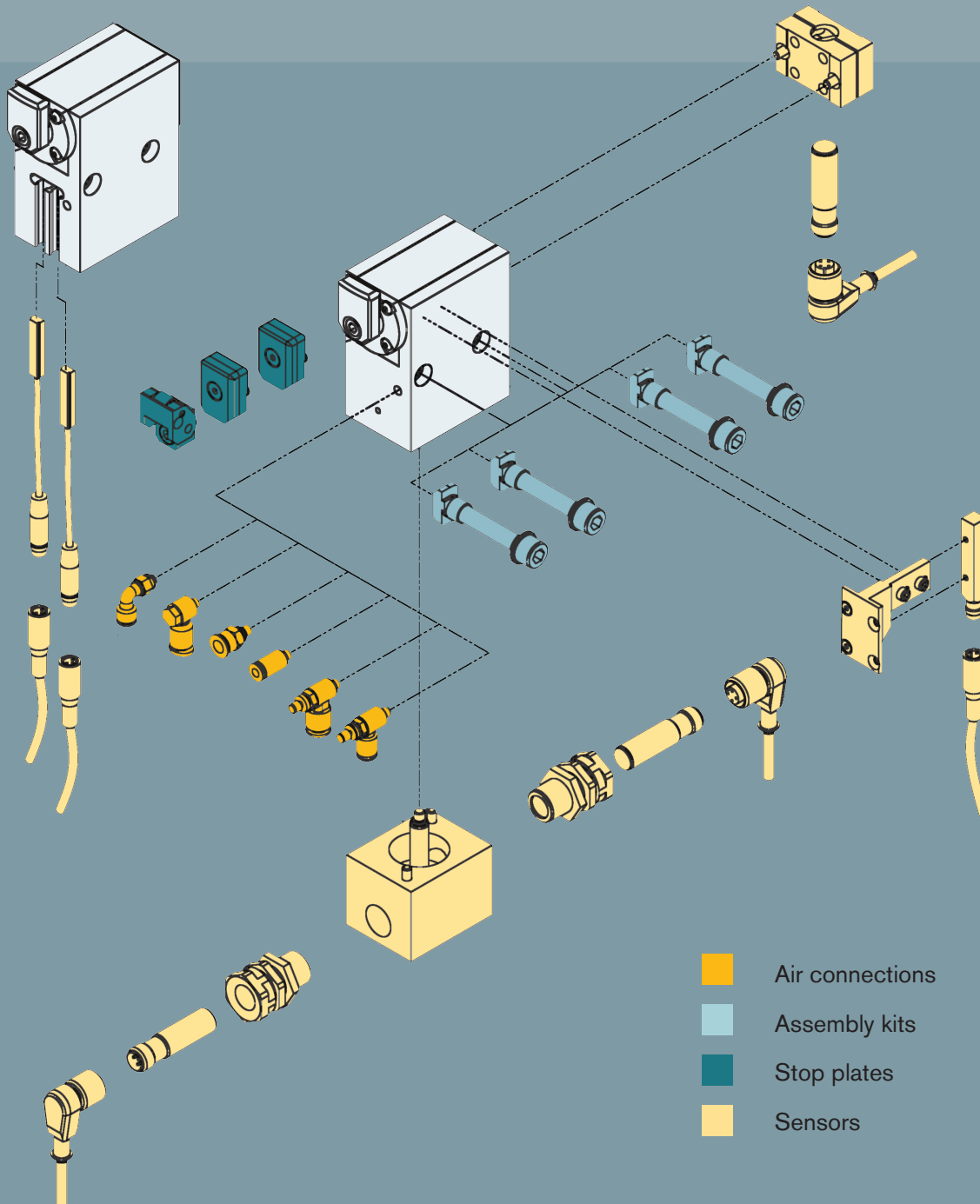

Product-independent accessories	Basic product	Variants
Position sensor for pallet	DP	AU / AS cust.-spec. solutions
Sensor bracket	DSA	H/K cust.-spec. solutions

- H heat-resistant
- K cold-resistant
- AU bottom-mounted sensor
- AS side-mounted sensor

Calculation aid

Maximum WT weight as a function of friction coefficient and conveying speed

You want to know the max. WT weight for a different conveying speed and/or a different coefficient of friction?

Then you can easily determine the max. WT weight for your application using the calculation aid at

www.woerner-gmbh.com/support.

Or simply contact our service hotline directly at:

Telefon: +497116016090

E-Mail: sales@woerner-gmbh.com

Technical explanations

Basic function: Lowering

Propelling force F_R

The propelling force F_R is the friction force between the conveyor equipment and the pallet. It is a function of the coefficient of friction μ , the weight of the pallet m and acceleration due to gravity g :

$$F_R = \mu \cdot m \cdot g$$

If more than one pallet has been accumulated than the number of pallets n must also be considered:

$$F_R = n \cdot \mu \cdot m \cdot g$$

The coefficient of friction μ is a function of the friction between the conveyor equipment and the pallet.

Examples for the coefficient of friction:

Belt/band:	$\mu = 0.2$ to 0.3
Plastic modular belt:	$\mu = 0.3$ to 0.5
Accumulation roller chain:	$\mu = 0.01$ to 0.03

Example calculation:

$m_{\text{workpiece}}$	= 5 kg
m_{pallet}	= 2 kg
μ	= 0.2
g	= 9.81 m/s ²

$$F_R = (5 + 2) \text{ kg} \cdot 0.2 \cdot 9.81 \text{ m/s}^2 = \mathbf{13.7 \text{ N}}$$

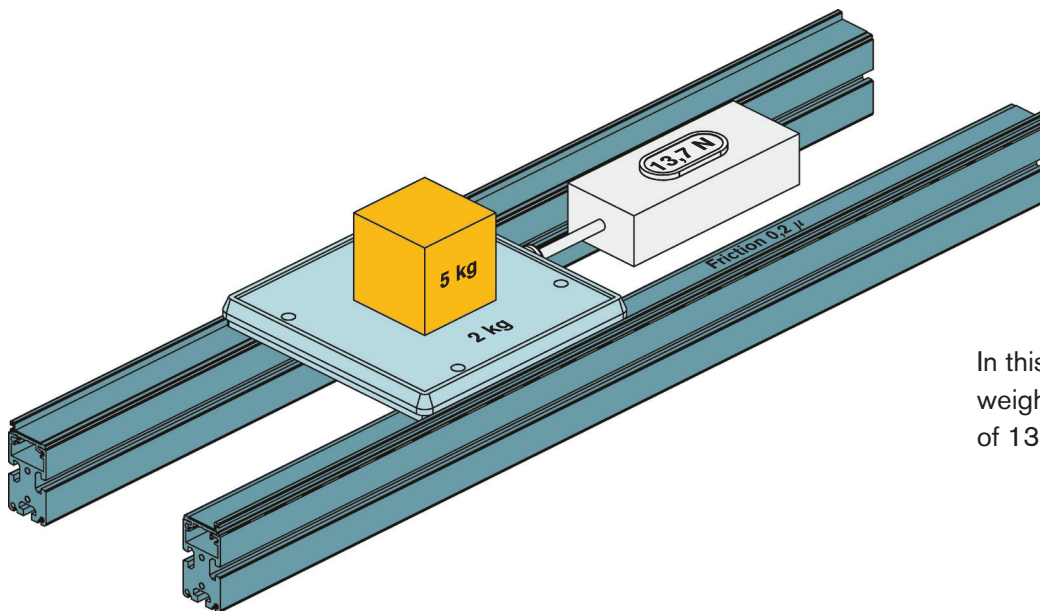

In this example, a pallet of total weight 7 kg exerts a propelling force of 13.7 N on a double belt conveyor.

The product brochure and data sheets indicate the maximum propelling force against which the stopper can reliably lower during long-term operation. The propelling force in your system must be less than the specified value.

Example for DBS-20/60:

(Value given for coefficient of friction $\mu = 0.07$):
Maximum propelling force 41 N

Please note that other pallet weights can be reliably lowered at different coefficients of friction. Using the formula above, you can easily convert the maximum propelling force specified by us for other coefficients of friction.

We would be happy to advise you – just contact us!

Basic function: Stopping

Deceleration force F_v

(by way of example for damped stopper)

The deceleration force F_v is required to slow the pallet down to a halt and dissipate the kinetic energy stored in the pallet. It consists of the damping force (at conveyor speed v and damping stroke s) and the propelling force, which continues to have an effect even during the damping operation:

$$F_v = \frac{m \cdot v^2}{2s} + m \cdot g \cdot \mu$$

The scope of application of the various stoppers is indicated in the product brochure and data sheets. Using these tables, it is easy to determine whether the intended stopper is able to damp the expected pallet weight at your required conveyor speed.

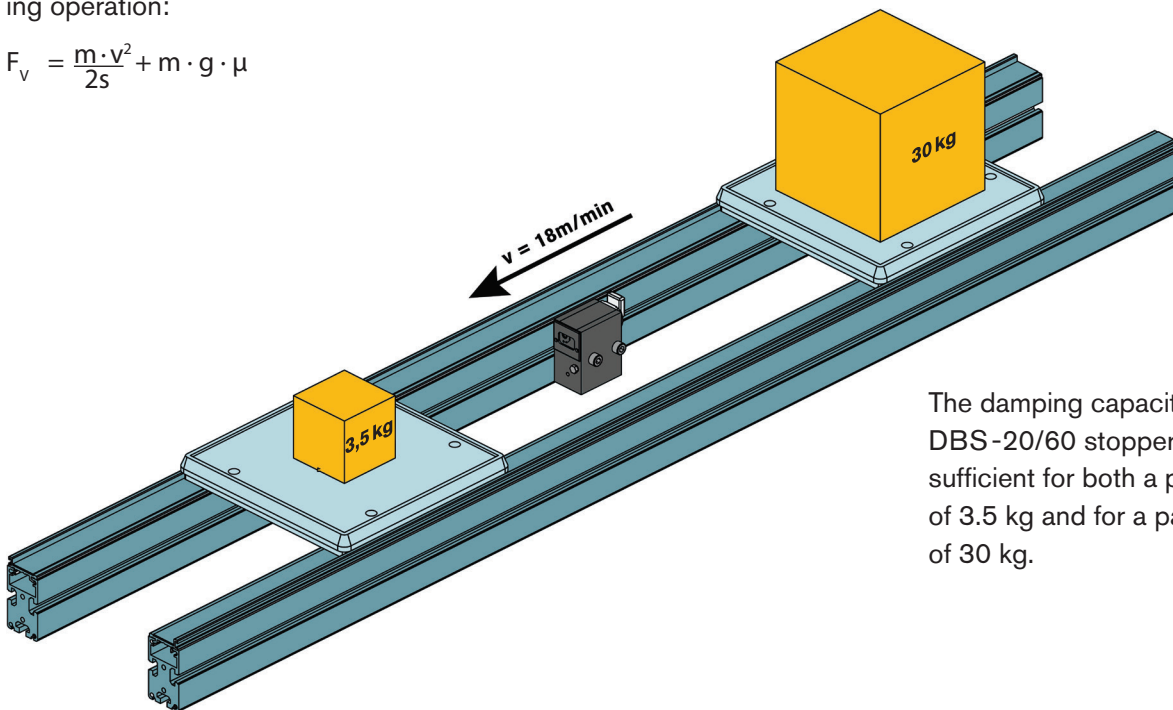

The damping capacity, e.g. of a DBS-20/60 stopper at 18m/min, is sufficient for both a pallet with a weight of 3.5 kg and for a pallet with a weight of 30 kg.

Example for DBS-20/60

(Values given for coefficient of friction $\mu = 0.07$):

Conveyor speed

6 m/min
9 m/min
12 m/min
18 m/min
24 m/min
30 m/min
36 m/min

Pallet weight

3.5 - 60 kg
3.5 - 40 kg
3.5 - 35 kg
3.5 - 30 kg
3.5 - 24 kg
3.5 - 18 kg
3.5 - 10 kg

Please note that other combinations of the conveyor speed and pallet weight parameters are possible, or may indeed be required, at different coefficients of friction. This is true, in particular, when the propelling force accounts for a high proportion of the deceleration force, i.e. in systems with high levels of friction.

You can obtain an initial approximation of these values using the formula above.

We would be happy to advise you – just contact us!

Overview of the Wörner product system

Product portfolio

Damping, stopping and positioning modules for automation technology

Product families

Stoppers

Angle dampers

Index cylinders

Anti-bounce stops

Product groups

undamped
pneumatic

damped
pneumatic

undamped
electric

damped
electric

damped
for roller
systems

Accellera-
tion Units

Displace-
ment Stops

Basic products¹

by scope of application, e.g. D0-400, DBS-20/60, ELU-30-KI, DEL-60, DBSR-550

Product variants²

e.g. in terms of lowering stroke, operating principle, stop, sensors, etc.

¹ The basic products differ in their scope of application, primarily in terms of the maximum pallet weight that can be stopped.

² The product variants – i.e. the products that can be ordered – are determined by selecting the required technical characteristics, for example in terms of lowering stroke, function, temperature range or stop design.

Order code

You can identify the product variant that is right for your application by consulting the relevant basic product data sheet.

You can choose between the variants defined there, for example on the basis of the lowering stroke, function, temperature range or stop design.

We would be delighted to assist you in choosing your product variant or by developing a custom product tailor-made for your application.

The example opposite illustrates the composition of the order code for a pneumatically driven, damped stopper of type DBS-20/60.

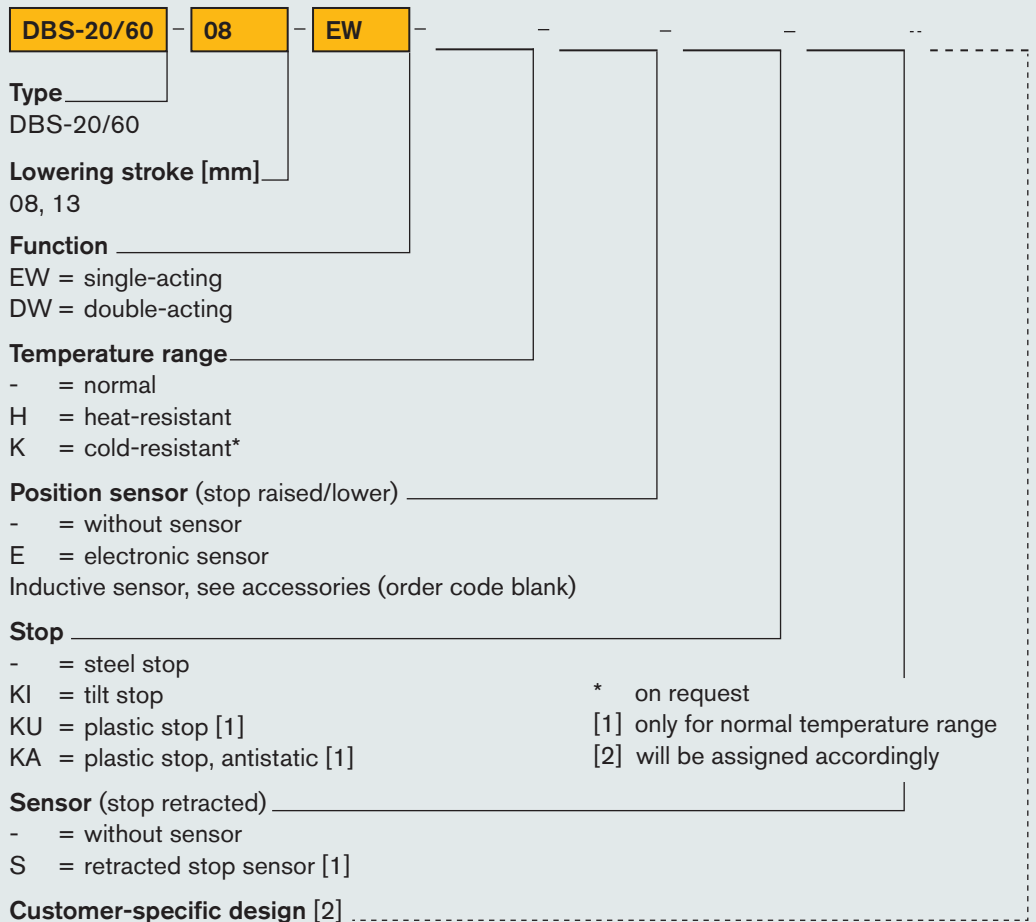

Glossary

Air consumption

A unit's compressed air consumption expressed in litres per work cycle, usually at a working pressure of 6 bar.

Angle damper

For stopping with change of direction. Preferred solution for changes of direction during the conveying of shock-sensitive or fragile parts.

Anti-bounce stop

For preventing rebound. Holds the pallet loaded with individual parts in position with absolute precision to prevent any rebound. Used in particular in combination with undamped stoppers.

Basic product

Standard products that are differentiated according to area of application (essentially according to the maximum pallet mass to be stopped) and serve as the basis for individual product variants.

Coefficient of friction

Designates the friction between the conveyor equipment and pallet. Important for the design of the stopping point because both the damping and the lowering capacity depend on the friction.

Conveyor speed

Speed at which the pallet is transported.

Damping stroke

Distance travelled by the stop when decelerating the pallet. The length of the damping stroke is important for the stopper's damping capacity.

Deceleration force

Required to slow the pallet down to a halt and dissipate the kinetic energy stored in the pallet. It consists of the damping force and the propelling force, which continues to have an effect even during the damping operation.

Electronic sensor

Electronic, non-contact sensor system for the detection of certain stop positions.

Friction

Force required to set a stationary body in motion or to continue to move a moving body in a constant way. Is a function of the coefficient of friction and weight of the body.

Index cylinder

For raising and positioning. Guarantees precise positioning and vertical lifting of the pallet and is ideal for rapid positioning tasks. The workpiece can be processed without vibration.

Inductive sensor

Inductive, non-contact sensor system for the detection of certain stop positions.

Lowering stroke

Distance travelled by the stop to clear and lock (lower or raise) the pallet.

Operating pressure

Working pressure of the pneumatic system. Specifications in data sheets (for the lowering force, for example) usually refer to a operating pressure of 6 bar.

Order code

The order code reflects the composition of a product variant and uniquely identifies this. It is possible to order directly from Wörner using this code.

Pallet weight

Weight of the pallet and/or the workpiece.

Position sensor

Accessory available for many stopper models. Can be used to determine the position of the stop. For full functionality, further accessories are required (proximity switch, for example).

Product variant

Variant derived from a basic product (for example in terms of lowering stroke, function, temperature range or stop design). The name of the product variant corresponds to the order code that can be used to order the unit from Wörner.

Propelling force

Friction force between the conveyor equipment and pallet. Is a function of the coefficient of friction, pallet weight and acceleration due to gravity.

Scope of application

Identifies a stopper's damping capacity. Table specifying the maximum pallet weight that can be stopped at different conveyor speeds.

Separating stop, damped

For stopping and clearing pallets. For shock-sensitive, fragile parts. Pallets are gently decelerated as they arrive so that workpieces reach their final position without rebound. The forces transferred to the conveyor system are considerably reduced.

Separating stop, undamped

For stopping and clearing pallets. Tough, economical basic design. Suitable for use wherever one or more pallets are to be accumulated at a defined position.

Single-acting

Lowering is a pneumatically or electrically driven movement. By contrast, the stop is raised into the locking position by spring force. Benefits: Easier to control because, for example, only one pneumatic connection is needed. When no compressed air is supplied, the stopper always moves to the locked position (safety feature).

Stop

Component on which the WT hits. Available in different versions and dimensions (plastic, steel or tilt stop). Material pairing between WT and stop is important for the achievable lowering force.

Wörner worldwide

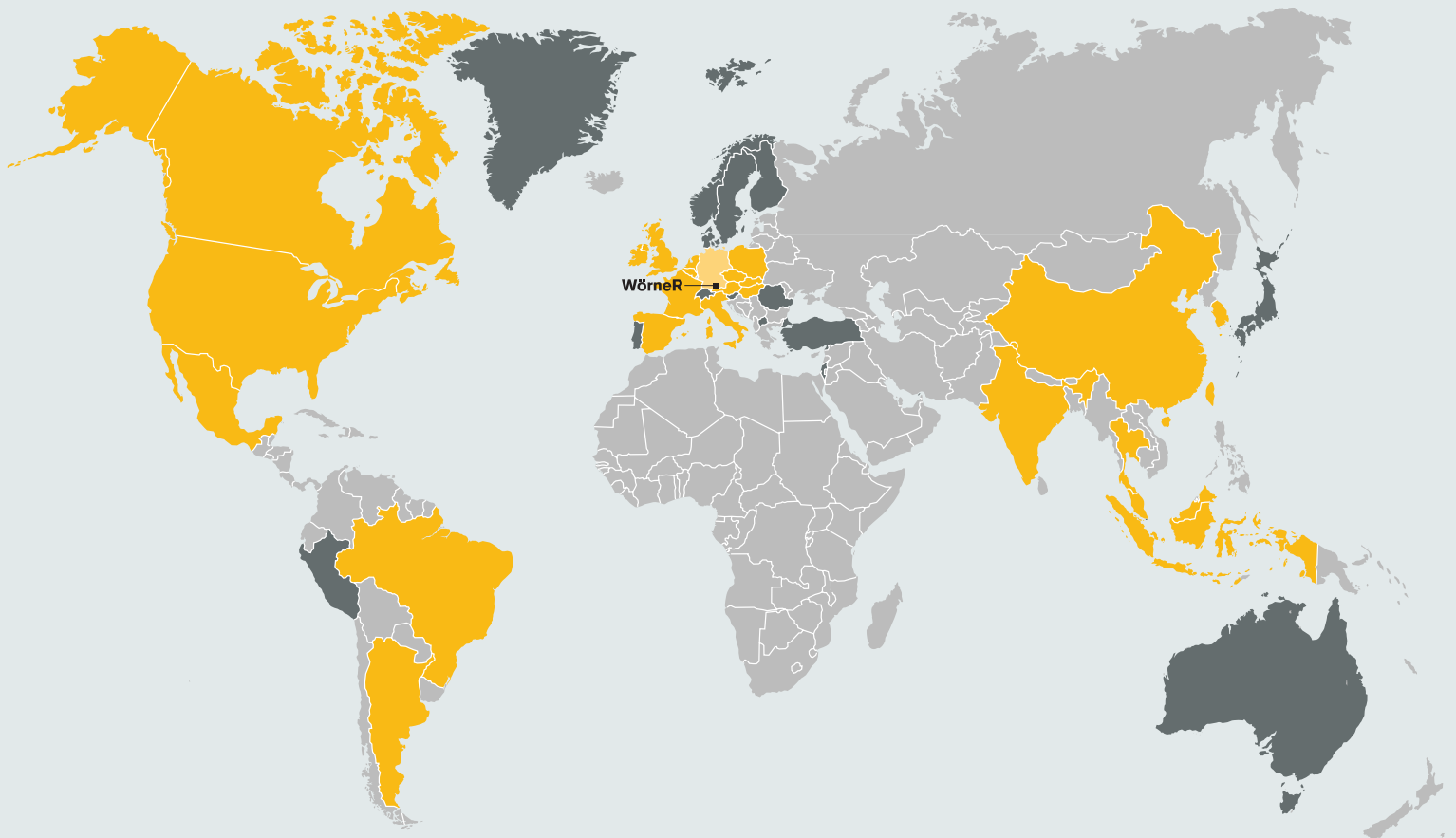

- Countries with regional sales offices or partners
- Countries with well-established customer relationships

Contact details of our international sales partners are available on our website: www.woerner-gmbh.com

Contact us for more

We are committed to exceptional service and support.

If you should have any questions related to products, orders or shipments, or if you should require personal advice, simply contact our headquarter in Denkendorf. We will put you in touch with a representative who understands your needs.

Wörner Automatisierungstechnik GmbH

Rechbergstraße 50
73770 Denkendorf
Germany

Tel. +49 711 601 609-0
Fax +49 711 601 609-10

sales@woerner-gmbh.com
www.woerner-gmbh.com