



The most advanced range of **electric wheels**  
for **assistance to manual handling**.

PRODUCT  
GUIDE



V-EN, Copyright© 2021 ez-Wheel company



ez-wheel.com



# Summary

## 1. ez-Wheel p.03

Company	p.04
Technology	p.06
Product features guide	p.08

## 2. Business Sectors p.09

Industry	p.10
Automotive	p.12
Food processing	p.14
E-Commerce / Retail	p.16
Medical / Pharmaceutical	p.18
Public spaces	p.20

## 3. Wheels p.22

Series 300I	p.24
Series 300M	p.26
Series 300F	p.28
Series 150I	p.30
Series 160M	p.32
Series 10''	p.34

## 4. ez-Config® p.36

## 5. Product compatibility p.38

## 6. Accessories p.40

Smart controls	p.40
ez-Box®	p.44
Wired hand controls	p.46
Wired switches	p.48
Batteries	p.50
Mechanical accessories	p.52
Chargers	p.54

## 7. Contact p.56

## 8. Index p.58



# The most advanced range of electric wheels



## Concentrate of technology

- ✓ integrated wheel drive
- ✓ patented technology
- ✓ award-winning



## Modularity & simplicity

- ✓ the only autonomous and universal drive wheel
- ✓ multiple applications
- ✓ wide range of accessories



## ★ ★ ★ All-star Mobility

- ✓ prevents musculoskeletal disorders
- ✓ improves working conditions
- ✓ modernizes industrial tools

The ez-Wheel® is a simple and efficient solution to quickly bring electric assistance to any rolling equipment or vehicles.

Applied to manual equipment, it can solve major issues for employees as well as for companies:

- reduces professional risk, especially MSD\*
- helps to reduce sick leave and offers an increase in productivity of up to +50%
- doubles the load for a fifth of the effort
- generates a return on investment in less than 1 year

\*Musculoskeletal disorders



# An innovative French company

ez-Wheel SAS is an innovative technology company founded in 2009. Based in Angoulême - in South-West France, the company develops a range of industrial electric traction solutions dedicated to handling equipment and green mobility.

## A R&D-driven strategy

The company dedicates most of its resources to Research and Development into innovating methods. The ez-Wheel team's industrial experience ensures good assessment and management of the risk related to the delivery of innovative products to market. The product's embedded features correspond to those usually required by professionals in the field and the production process uses controlled and standardized methods.

## Eco-design

Our products have been developed following a life-cycle in which **production**, **use** and **end-of-life** conditions are taken into consideration from the **design** phase.

A lot of effort is made regarding the choice of components and the integration of mechatronics, with the intention of delivering to market reliable, powerful, sustainable and eco-friendly products, to satisfy your mobility issues.

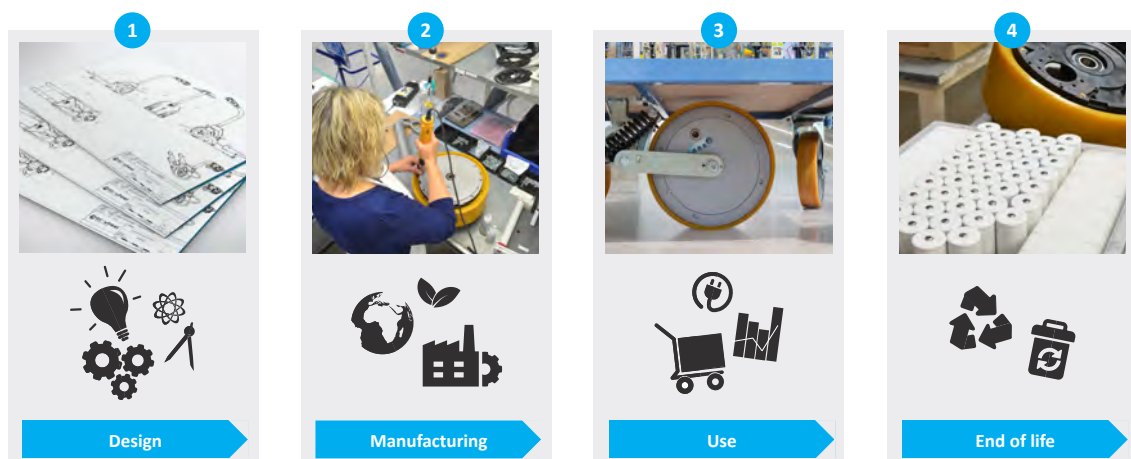



## Strong industrial partners

The production process is ensured by industrial partners selected on quality, competitiveness and local criteria, monitored by our quality/manufacturing departments and outside organizations.

Since 2012, ez-Wheel has been authorised to use the "ORIGINE FRANCE GARANTIE" quality label on its products.

Delivered by approved organisations (PRO France and Bureau Veritas) this certification is obtained by meeting precise tender specifications that validate the manufacturing origin of products in the French national territory.



## Implementation promoting the mechatronics innovation

Founded and located in Charente, a strategic location for electric motors and batteries in the Nouvelle-Aquitaine region, ez-Wheel benefits from geographical and economic advantages provided by a number of industrial players and SMEs implanted locally. The innovative technology of ez-Wheel is the result of recognized expertise and local know-how going back over 50 years.



# The first electric wheel integrating motor and batteries

ez-Wheel proposes the first electric wheel featuring embedded motor, batteries and electronics, bringing electrical assistance to rolling equipment. Thanks to optimal integration of the motor, batteries, and electronics inside the hub, the wheel can be fixed quickly and easily – **a safe, clean and quiet solution.**

## Quick fitting

ez-Wheel® wireless technology removes all the peripherals, wire sets and connectors from the chassis, making the integration of our solutions a fast and easy task compared to other alternatives.

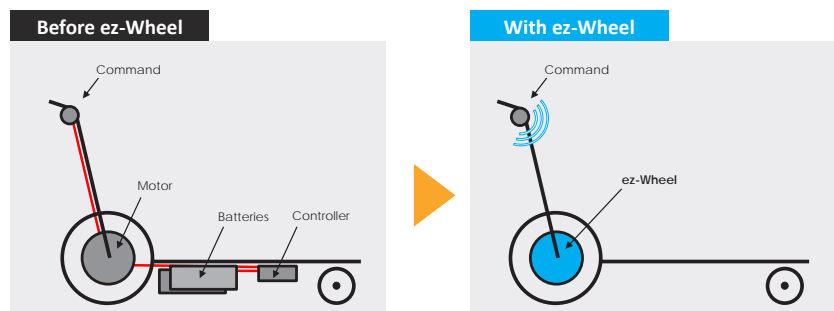

## Designed to last

ez-Wheel® products are ready to operate in outdoor or indoor conditions, over an extended temperature range.

All the components including the battery are designed to withstand up to 7 years of operation without any maintenance required, confirmed by real returns on experience.

**IP43**  
**IP66**

Protection Index

**-20°C**  
**+60°C**

Functional temperatures range

**3Y.**  
**7Y.**

Maintenance period in years



## The solution fully integrates into a wheel all the functions of a conventional power train:

- ✓ high-end electric motor
- ✓ high energy and super long-life batteries
- ✓ power controller featuring state of the art motor control
- ✓ battery management
- ✓ wireless interface



### Cover

All components of the autonomous wheel are contained in a robust and totally waterproof cover. The wheel is able to operate in the toughest environments.

### Motor

The high torque and ultra-compact drive is ensured by a high-tech permanent magnet motor, and a mechanical reducer fully integrated into the wheel's architecture.

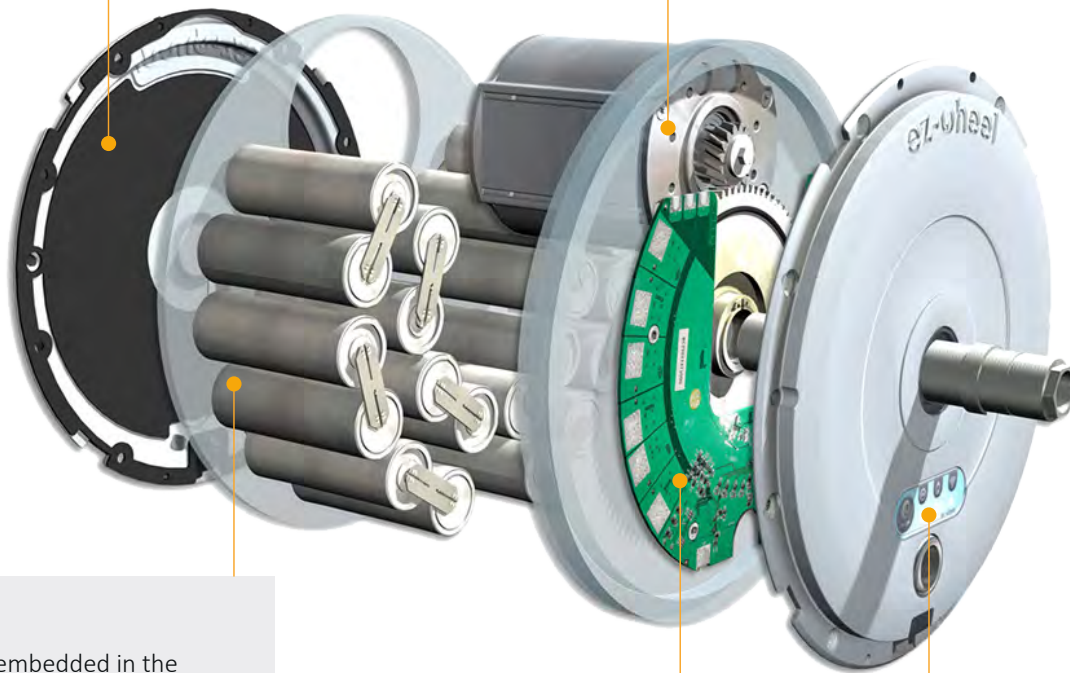

### Battery

The energy embedded in the wheel is stored in a cutting-edge Ni-MH battery. Built to last, rock-solid and reliable, this technology is also one of the safest available on the market.

### Electronics

The brain of the wheel is powered by two micro-controllers and two real-time operating systems. It enables wireless communication, battery management and full customization of the wheel's features.















### HMI

The user interface is extremely simple. It includes the wheel's recharge connector, a diagnostic button, and lights indicating the wheel, battery level and wireless communication status.

# Product features guide

## Follow the guide!

Our products offer is developed for specific environments and needs. The following pictograms will help you quickly define the product's main characteristics.

Help guide Aid to comprehension		<b>IP43</b> Index	Solid objects greater than 1 mm Sprays of water at any angle up to 60°
Wireless communication		<b>IP54</b> Index	Limited ingress of dust Splash-proof from all directions
Serial Link communication		<b>IP65</b> Index	Dust-proof Water jets
Enables regenerative charging from wheel rotation		<b>IP66</b> Index	Dust-proof Powerful Water jets
Maintenance free Lifespan 3 to 7 years		<b>IP69K</b> Index	Dust-proof High pressure and high temperature
Designed to run quietly			Hygienic design
Up to 1 ton moved			Non-slip tyre
Heavy load moved			Shockproof
Audible warning			High-pressure jet-cleaning
Internal or External battery			Stainless-steel



# Business Sectors

Endless possibilities

Power any rolling equipment dedicated to load handling or people transportation, quickly and easily.

## INDUSTRY

p.10



## AUTOMOTIVE

p.12



## FOOD PROCESSING

p.14



## LOGISTICS / RETAIL

p.16



## MEDICAL / PHARMACEUTICAL

p.18



## PUBLIC SPACES

p.20



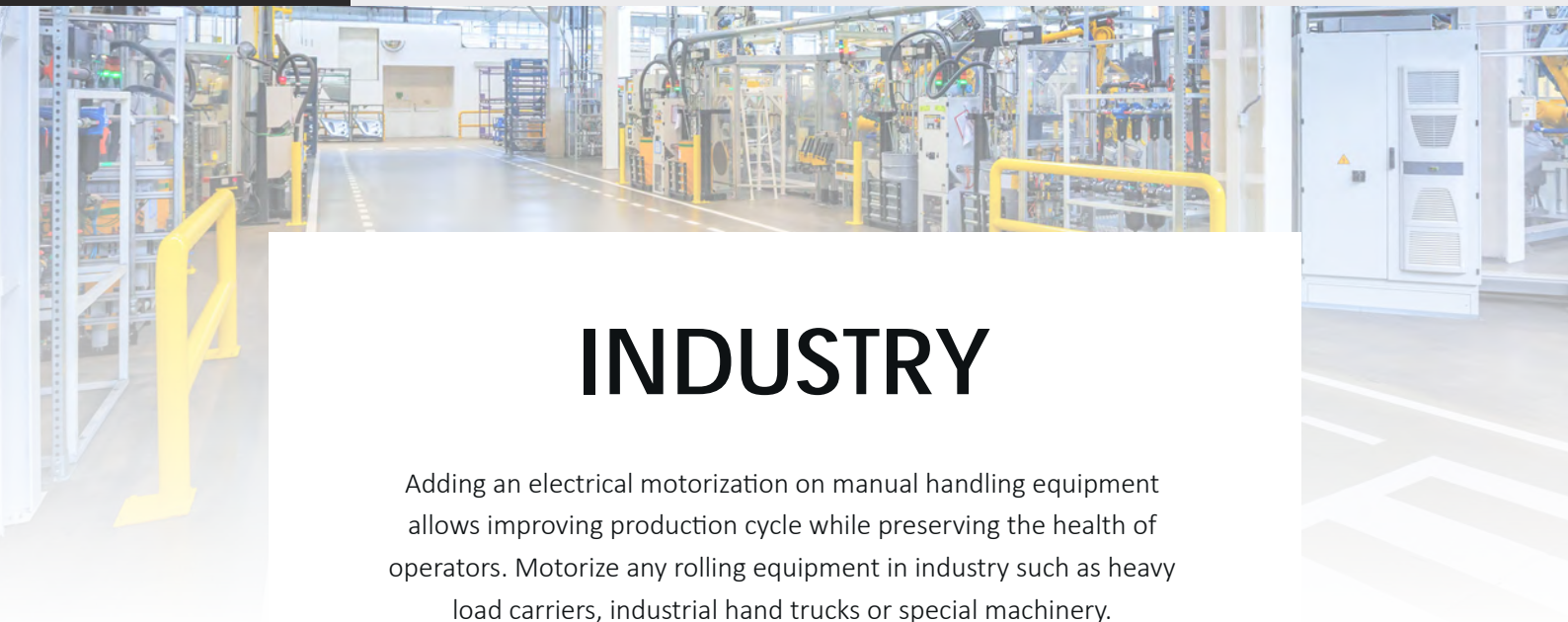

# INDUSTRY

Adding an electrical motorization on manual handling equipment allows improving production cycle while preserving the health of operators. Motorize any rolling equipment in industry such as heavy load carriers, industrial hand trucks or special machinery.

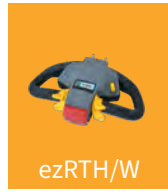

## Endless possibilities:



<b>Application</b>	Heavy load carriers
<b>Wheel</b>	ezW300I/WR electric wheel
<b>Accessories</b>	ezRTH/W smart control



<b>Application</b>	Industrial hand trucks
<b>Wheel</b>	ezW150I electric wheel
<b>Accessories</b>	ezARH control External battery



<b>Application</b>	Special machinery
<b>Wheel</b>	ezW300I/WR electric wheel
<b>Accessories</b>	ezR44IN/W interface ezAAR control

## They trust us:





# Suitable for the Industrial sector

Up to 2 tons moved without effort!

ez-Wheel® self-propelled electric wheels are ideal for handling equipment and moving heavy loads.



## ◀ Up to 2 tons

Wheels can be paired to double the moved-load capacity. This platform has been fitted with 2 ezW300I/WR wheels and the load being moved is 2 tons.



## ◀ Continuous conveying

The transfer carriage or carousel can easily be powered to ensure repetitive motions. This example is fitted with 2 external batteries to allow for continuous use.

## ▲ Wireless control

The ezW300I/WR wheel is made for heavy load/large dimensions travel assistance. Its Wireless control offers great freedom of the manual control.



## ◀ Special machinery

Most industrial special machinery can be fitted with ez-Wheel® electric wheels and accessories.

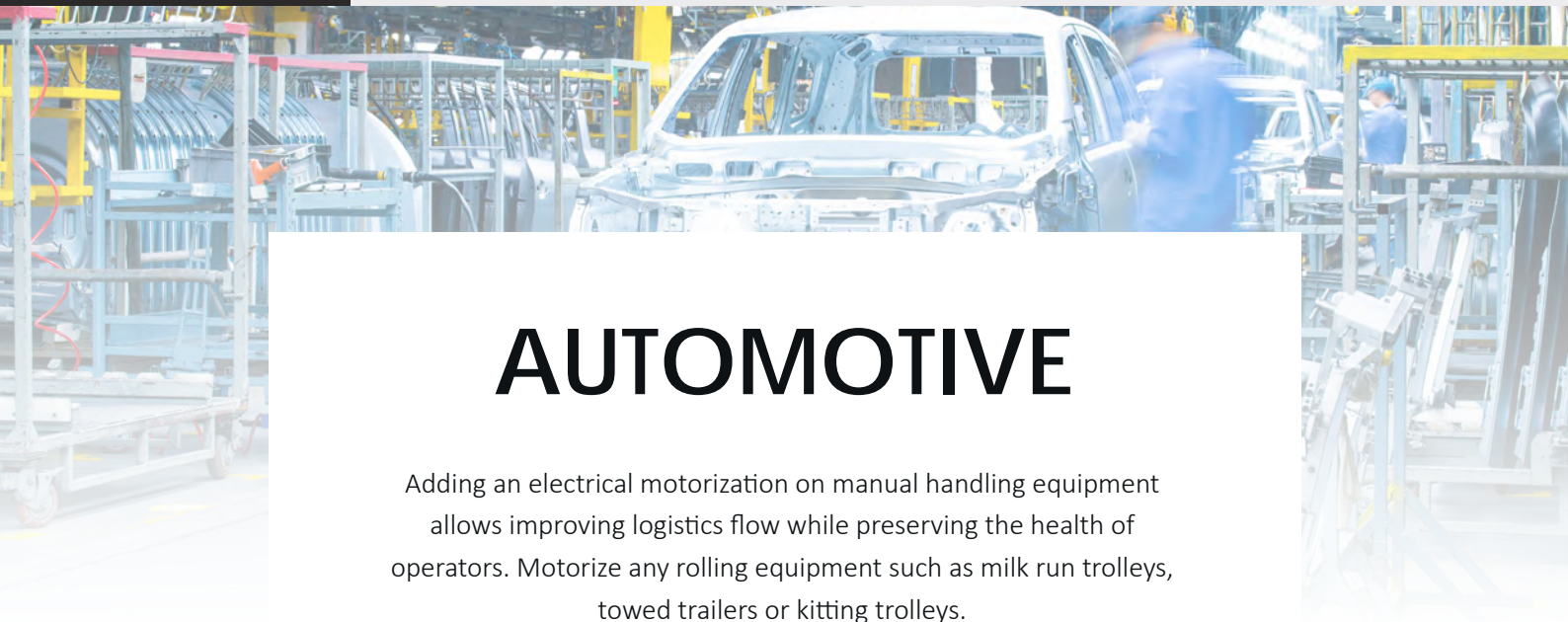

# AUTOMOTIVE

Adding an electrical motorization on manual handling equipment allows improving logistics flow while preserving the health of operators. Motorize any rolling equipment such as milk run trolleys, towed trailers or kitting trolleys.



## Endless possibilities:

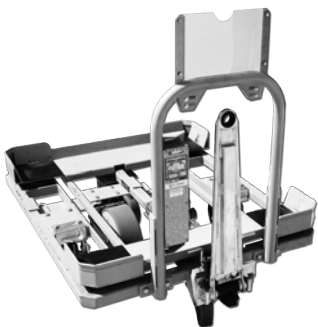

<b>Application</b>	Milk run trolleys
<b>Wheel</b>	ezW300I/WR electric wheel
<b>Accessories</b>	ezMCS/H suspension bracket ezR44IN/W interface Specific button control (on request)



<b>Application</b>	Towed trailers
<b>Wheel</b>	ezW300I/CCR electric wheel
<b>Accessories</b>	ezMCS/H suspension bracket ezRPP/UC sensitive control



<b>Application</b>	Kitting trolleys
<b>Wheel</b>	ezW150I electric wheel
<b>Accessories</b>	ezMCS/160 suspension bracket ezARH control

## They trust us:





# Suitable for Automotive Industry

Ensuring continuous service

ez-Wheel® regenerative charging during towing feature is the perfect fit for towed material running 24/7.



## ◀ Regen charge while towing

ezW300I/WR and ezW300I/CCR electric wheels equipped with the « Regen » option can recharge themselves whilst being towed between the warehouse and the production line.

## ◀ Moving platform

Operators movements may be also assisted by electric wheel ez-Wheel®. This motorized platform is foot-controlled, allowing you to follow the overhead line movement.

## ▲ Sensitive control

The ezRPP/UC push-pull sensitive control resulting from collaboration with a well-known automotive group, is perfect for manoeuvring on the shop floor.



## ◀ Charging at workstation

ezW300I/CCR and ezW150I ez-Wheel® electric wheels, can be recharged on each back-to-workstation through recharge contacts. The built-in batteries are designed to go through many micro-charging cycles without any premature ageing risks.



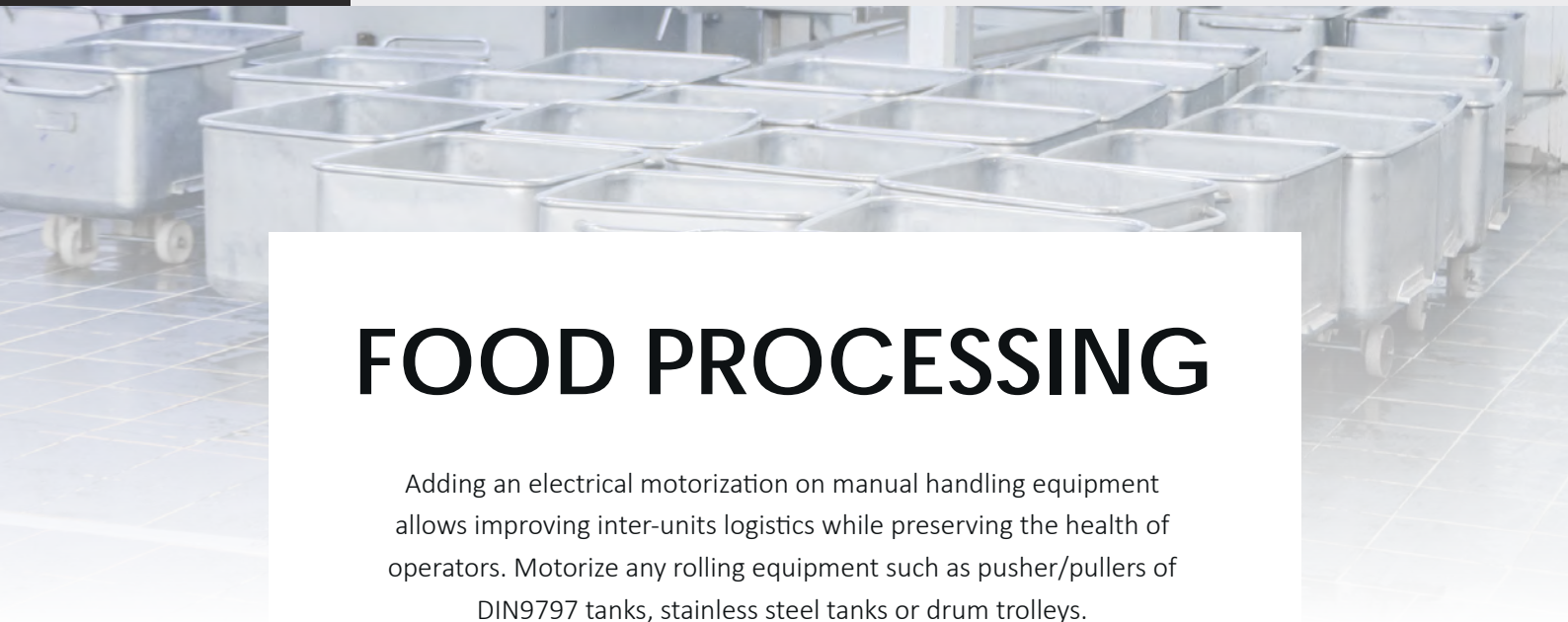

# FOOD PROCESSING

Adding an electrical motorization on manual handling equipment allows improving inter-units logistics while preserving the health of operators. Motorize any rolling equipment such as pusher/pullers of DIN9797 tanks, stainless steel tanks or drum trolleys.

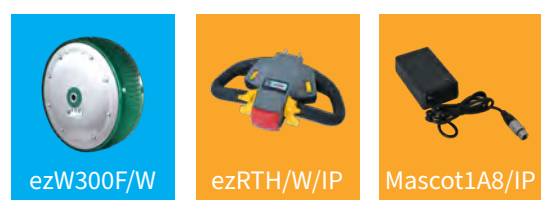

## Endless possibilities:



<b>Application</b>	Pusher/pullers
<b>Wheel</b>	ezW300F/W electric wheel
<b>Accessories</b>	ezRTH/W/IP smart control



<b>Application</b>	Stainless steel tanks
<b>Wheel</b>	ezW300F/W electric wheel
<b>Accessories</b>	ezRTH/W/IP smart control



<b>Application</b>	Drum trolleys
<b>Wheel</b>	ezW300F/W electric wheel
<b>Accessories</b>	ezRTH/W/IP smart control

## They trust us:



# Suitable for Food processing

Reinforced for serious tasks

ez-Wheel® sealed and waterproof products can operate in severe environments over a wide temperature range.



## ◀ Precise manoeuvre

The accurate motorization control allows precise positioning of machines. Here, a wine tank motorized by 2 ezW300F/W. Thanks to ez-Wheel® devices, the operator can easily position the tank above the fill access cover.

## ◀ High pressure jet cleaning

The highest protection index **IP69K** and the stainless-steel cover of the ezW300F/W wheel allows high pressure jet cleaning, the robustness of the assembly being reinforced by the absence of connectors and fragile units.

## ▲ Wireless

ezW300F/W wheel controlled by the ezRTH/W/IP tiller head offers a wireless solution without connector, perfect for demanding and wet environments.



## ◀ Production machinery

Even the most complex production machineries can be motorized by ez-wheel® electric wheels, thanks to its small dimensions and its standard form factor.

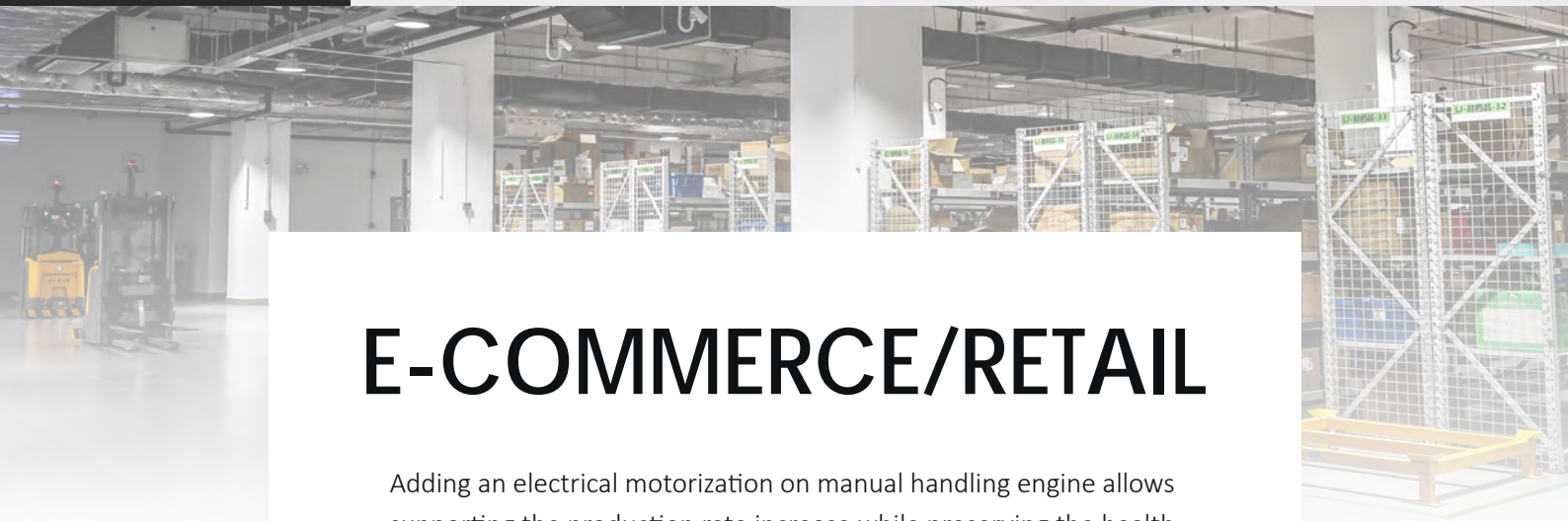

# E-COMMERCE/RETAIL

Adding an electrical motorization on manual handling engine allows supporting the production rate increase while preserving the health of order picker. Motorize any rolling equipment such as order preparation trolleys, picking trolleys or pusher/pullers.

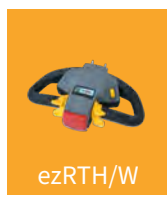

## Endless possibilities:



<b>Application</b>	Order preparation trolleys
<b>Wheel</b>	ezW160M+ electric wheel
<b>Accessories</b>	ezMCS/L/160+ suspension bracket Specific control (on request) External battery



<b>Application</b>	Picking trolleys
<b>Wheel</b>	ezW160M+ electric wheel
<b>Accessories</b>	ezMCS/160 suspension bracket ezARH-BD control



<b>Application</b>	Pusher/pullers
<b>Wheel</b>	ezW300I/WR electric wheel
<b>Accessories</b>	ezRTH/W smart control

## They trust us:





# Suitable for e-Commerce & Retail

Flexible, time-saving solutions

ez-Wheel® solutions are ideal for picking trolleys and platform trucks designed for hundreds of starts and stops per working shift.



## ◀ Multiple starts and stops

The ez-Wheel® electric wheels are specifically developed to ensure thousands of successive picking trolley starts and stops, and offer acceleration and deceleration assistance, with automatic motor brake and free-wheel control.

## ◀ Low height

The ezW160M+ electric wheel compactness with its castor standards dimensions facilitates mechanical integration, either as original equipment or retrofitted from existing trolleys.

## ▲ Full integration

The ezW160M+ wheels are easily integrated to control picking systems with other electronic components, such as these trucks fitted with Put-to-Light. The wheel is able to power the other components thanks to its on-board energy.



## ◀ Productivity gain

Motorization increases the carrying capacity and reduces the number of trips.

Here, a trolley's puller powered by the ezW300I/WR electric wheel moving a train of 4 preparation trolleys at the same time.

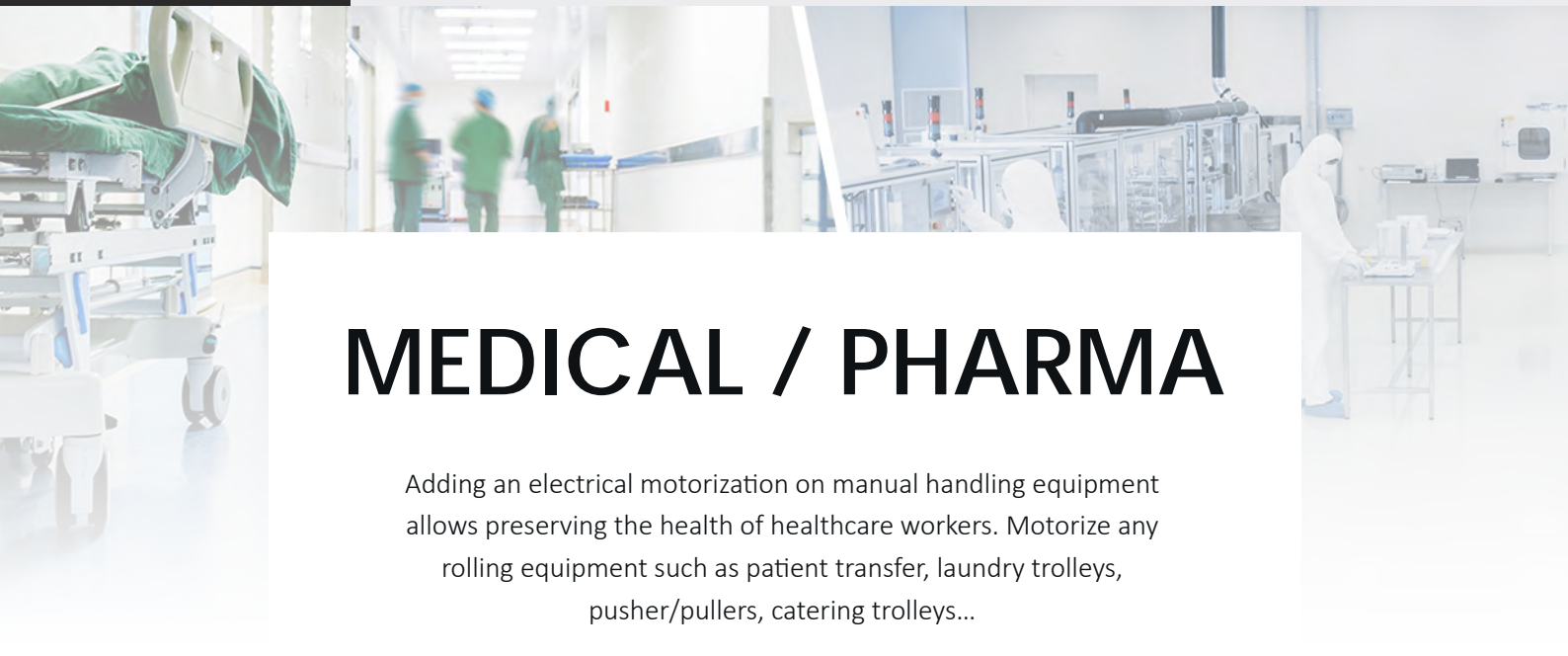

# MEDICAL / PHARMA

Adding an electrical motorization on manual handling equipment allows preserving the health of healthcare workers. Motorize any rolling equipment such as patient transfer, laundry trolleys, pusher/pullers, catering trolleys...

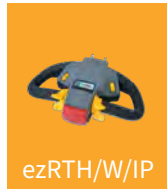

## Endless possibilities:



<b>Application</b>	Patient transfer
<b>Wheel</b>	ezW300M/W electric wheel
<b>Accessories</b>	ezR44IN/W interface ezARH control



<b>Application</b>	Laundry trolleys
<b>Wheel</b>	ezW160M+ electric wheel
<b>Accessories</b>	ezMCS/160 suspension bracket ezARH-BD control



<b>Application</b>	Pusher/pullers
<b>Wheel</b>	ezW300M/W electric wheel
<b>Accessories</b>	ezRTH/W/IP smart control

## They trust us:



# Suitable for Medical & Pharma

Clean, reliable and helpful

## Medical

ez-Wheel® self-propelled electric wheels are ideal to preserve the health of healthcare workers.



### ◀ Ability to climb slopes

The motorization offers a significant crossing torque, which allows a single person to climb slopes and access ramps without wasting time and effort.

### ◀ Multi-purpose

Most trolleys in hospitals can be motorized by ez-Wheel® electric wheels, either by direct motorizing, or by combining them with a motorized puller.

### ▲ Discreet & efficient

The ezW300M/W or ezW160M+ wheels are discreetly integrated to premium medical equipment, and their silent operation is highly appreciated by users.

## Pharmaceutical

ez-Wheel® pharma range is also made for clean-rooms / white rooms with the highest hygienic requirements.



### ◀ White and clean rooms

Thanks to its hygienic design and its special stainless-steel envelope, the ezW300M/W wheel can be used in a white and clean room.



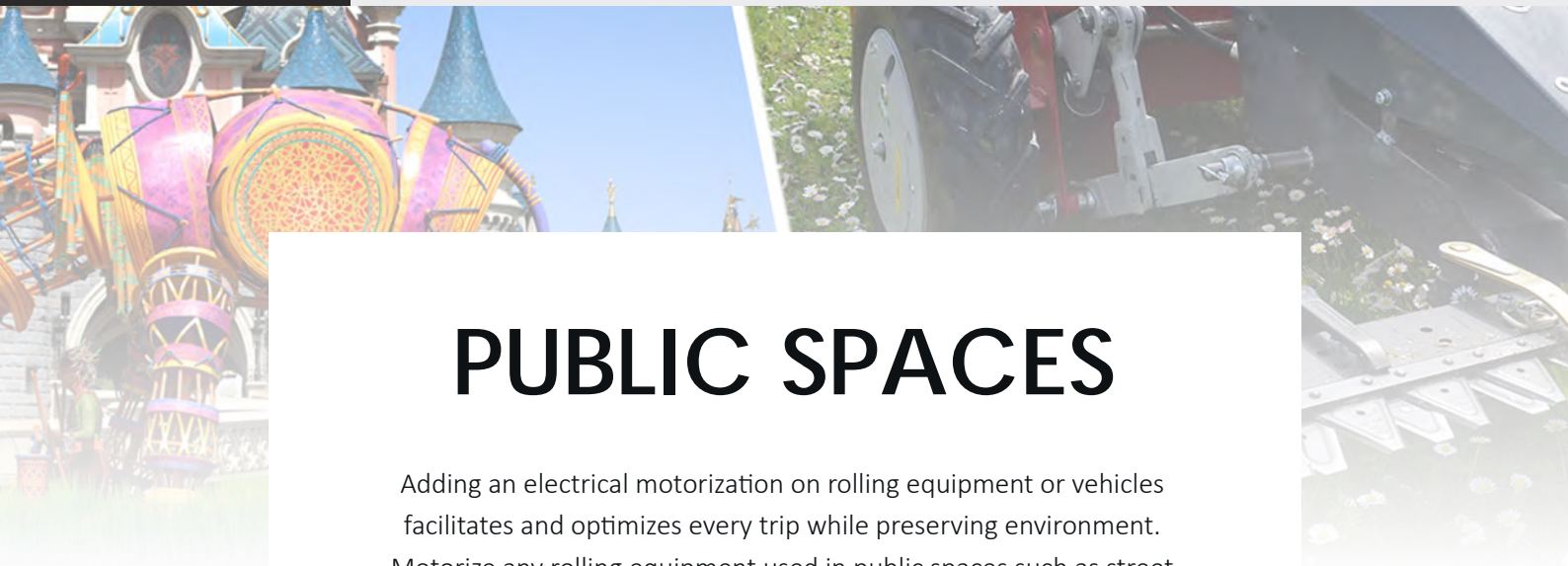

# PUBLIC SPACES

Adding an electrical motorization on rolling equipment or vehicles facilitates and optimizes every trip while preserving environment. Motorize any rolling equipment used in public spaces such as street trolleys, land drones, stage machinery.

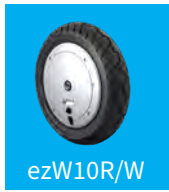

## Endless possibilities:



<b>Application</b>	Street trolleys
<b>Wheel</b>	ezW10R/W electric wheel
<b>Accessories</b>	ezR44IN/W interface ezAAR control



<b>Application</b>	Stage machinery
<b>Wheel</b>	ezW300I/WR electric wheel
<b>Accessories</b>	ezR44IN/U interface ezAAR control



<b>Application</b>	Special trolleys
<b>Wheel</b>	ezW300I/WR electric wheel
<b>Accessories</b>	ezRTH/W smart control

## They trust us:



# Suitable for Public spaces

Even for the craziest ideas

ez-Wheel® products can be used outside on bitumen or turf, as well as uneven terrain. The ez-Wheel® range offers a solution for every mobility need.



## ▲ It's show-time!

The ezW300I/WR wheels can be used on spectacular parade floats, both indoors and outdoors.



## ◀ Manoeuvrability

These two ezW10R/W wheels driven by two ezAAR joysticks allow all complex manoeuvres and are hidden under the full costume.

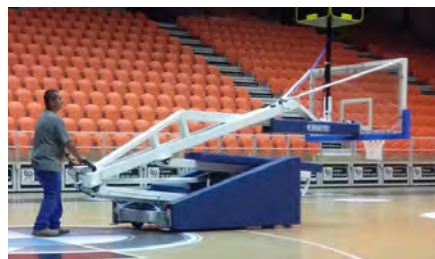

## ◀ Ability to react

ez-Wheel® devices can motorize the most bulky equipment quickly and easily, so just a single person is required for this kind of manoeuvre.



## ◀ Multi-environments

The ezW300I/WR or ezW10R/W wheels can be used on maintenance and delivery equipment or even agricultural machinery.



# ELECTRIC WHEELS

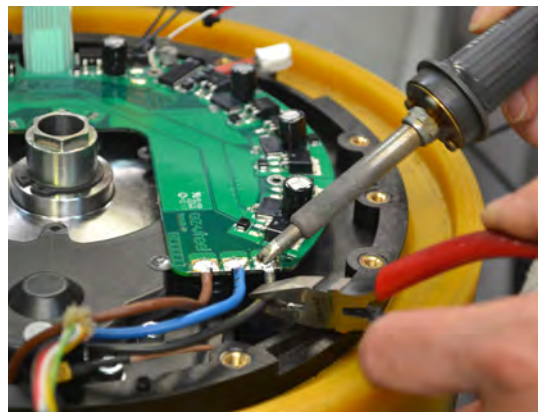



# ez-Wheel®

Electric wheel range



BYCert. 7359982

## Series 300

### electric wheel **Series 300I**

Developed for industrial use



p.24

### electric wheel **Series 300M**

Developed for the medical environment



p.26

### electric wheel **Series 300F**

Developed for the food processing industry



p.28

## Series 150/160

### electric wheel **Series 150I**

Developed for industrial use

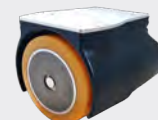

p.30

### electric wheel **Series 160M**

Developed for the medical environment



p.32

## Series 10''

### electric wheel **Series 10''**

Developed for the outdoors



p.34

# electric wheel Series 300I

Developed for industrial use



BV Cert. 7359982

All the components necessary for traction are built into the wheel: an electric gear motor, high energy and long-life batteries, a power controller ensuring optimum motor control, battery management and a control interface.



- Ø 300 mm
- 1000 kg moved
- IP54
- PU 80 sh.A flat profile



## Ref. ezW300I/WR



### Uses

- industrial handling tools
- towed rolling equipment
- trolley
- pusher/puller

### Technical features

Diameter	300 mm
Speed range	0 to 9 km/h
Peak pushing effort	35 daN Moves 1000 kg
Nominal performance	12 daN at 6 km/h
Maximum rolling speed	12 km/h
Battery capacity	240 Wh
Wheel weight	17 kg
Function +	Regen

## Ref. ezW300I/CCR



### Uses

- industrial handling tools
- towed rolling equipment
- trolley

### Technical features

Diameter	300 mm
Speed range	0 to 9 km/h
Peak pushing effort	35 daN Moves 1000 kg
Nominal performance	12 daN at 6 km/h
Maximum rolling speed	12 km/h
Battery capacity	240 Wh
Wheel weight	18 kg
Function +	Regen

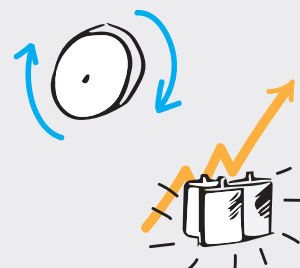

### Regen feature

Enables the built-in battery to be recharged using the kinetic energy produced by the rotation of the wheel.

*The wheel can be charged while rotating at a speed between 3 and 12 km/h, for instance during the towing phase of a trolley.*

*In this phase, the wheel switches into the charging mode automatically as soon as rotation is detected.*

*The wheel then presents a resisting (braking) torque and the braking energy recovered by the motor is injected back into the battery.*

Regenerative charging is an exclusive function developed by ez-Wheel.

FUNCTION +

## Weight

The robust assembly can withstand knocks and severe vibration and enables the wheel to carry some load.

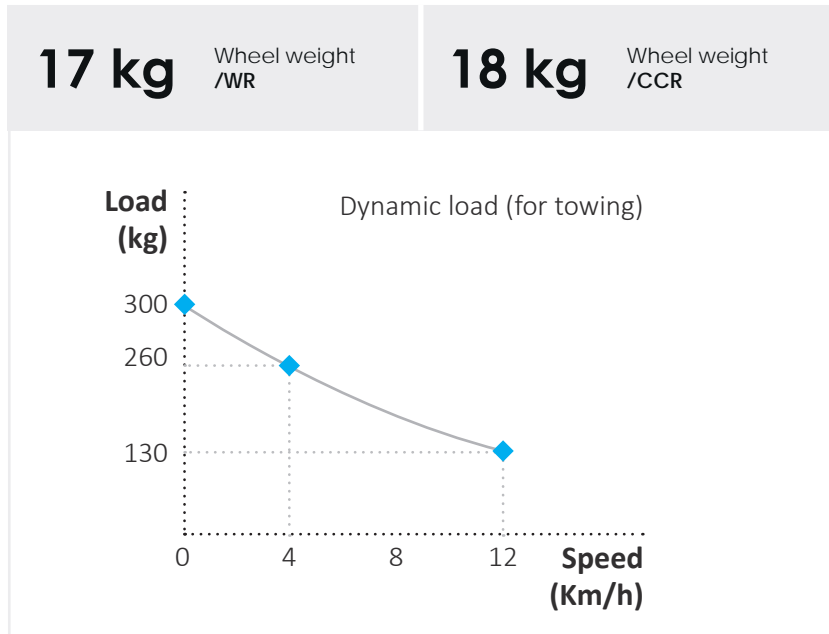

## Conditions of use

The wheel can be used inside or outside, over a wide range of temperatures. The components – including the battery – do not need any inspection or maintenance over the product's whole lifespan.

<b>-20°C</b> <b>+60°C</b>	Functional temperatures range	<b>5Y.</b> <b>7Y.</b>	Maintenance period in years
------------------------------	-------------------------------	--------------------------	-----------------------------

## Applications examples



- Heavy duty platform
- Special machinery
- Heavy load carrier

## Components specifications

### Motor

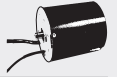

Technology	BLDC PM
Gearbox	1-stage helical
Indicative lifespan	5000 h / 15000 km 1500 000 starts/stops
Nominal Speed	110 rpm (6,2 km/h)
Nominal power	200 W (S1)
Peak Torque	52 Nm

### Battery



Electro-chemistry	Ni-MH long life
Energy	240 Wh 24 VDC - 10 Ah
Indicative lifespan	5-8 years
Recharge mode	- Charger - Towing /WR /CCR - External power
Minimum charging time	2.5 hours (to 90%)

### Interface



Wired	Serial
Wireless	LR WPAN 2.4 GHz IEEE 802.15.4



# electric wheel Series 300M

Developed for the medical environment



All the components necessary for traction are built into the wheel: an electric gear motor, high energy and long-life batteries, a power controller ensuring optimum motor control, battery management and a control interface.



- Ø 304 mm
- 1000 kg moved
- IP65
- 70 sh.A Polyurethane bomb profile

**Ref. ezW300M/W**



**Uses**

- medical devices
- pusher/puller

**Technical features**

<b>Diameter</b>	304 mm
<b>Speed range</b>	0 to 9 km/h
<b>Peak pushing effort</b>	35 daN Moves 1000 kg
<b>Nominal performance</b>	12 daN at 6 km/h
<b>Maximum rolling speed</b>	12 km/h
<b>Battery capacity</b>	240 Wh
<b>Wheel weight</b>	17 kg
<b>Option</b>	-

**Ref. ezW300M/W**



**Uses**

- medical devices
- clean room material
- pusher/puller

**Technical features**

<b>Diameter</b>	304 mm
<b>Speed range</b>	0 to 9 km/h
<b>Peak pushing effort</b>	35 daN Moves 1000 kg
<b>Nominal performance</b>	12 daN at 6 km/h
<b>Maximum rolling speed</b>	12 km/h
<b>Battery capacity</b>	240 Wh
<b>Wheel weight</b>	17 kg
<b>Feature</b> Ⓢ	Stainless-Steel recharge per contact

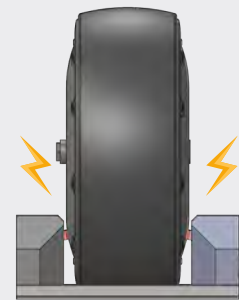

**Recharge per contact**

Enables the built-in battery to be recharged by direct contact on wheel sides.

Only available on:  
✓ stainless steel wheels

**FEATURE +**

## Weight

The robust assembly can withstand knocks and severe vibration and enables the wheel to carry some load.

**17 kg**

Wheel weight

**300 kg**

Vertical load

## Conditions of use

The wheel can be used inside or outside, over a wide range of temperatures. The components – including the battery – do not need any inspection or maintenance over the product's whole lifespan.

**-20°C**  
**+60°C**

Functional  
temperatures range

**5Y.**  
**7Y.**

Maintenance period  
in years

## Applications examples

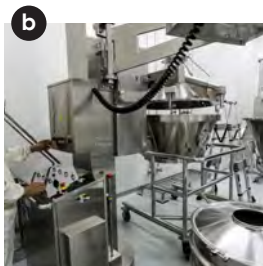

- a. Emergency stretcher
- b. Stainless steel tank
- c. Pusher/puller

## Components specifications

### Motor

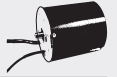

<b>Technology</b>	BLDC PM
<b>Gearbox</b>	1-stage helical
<b>Indicative lifespan</b>	5000 h / 15000 km 1500 000 starts/stops
<b>Nominal Speed</b>	110 rpm (6,2 km/h)
<b>Nominal power</b>	200 W (S1)
<b>Peak Torque</b>	52 Nm

### Battery



<b>Electro-chemistry</b>	Ni-MH long life
<b>Energy</b>	240 Wh 24 VDC - 10 Ah
<b>Indicative lifespan</b>	5-8 years
<b>Recharge mode</b>	Charger
<b>Minimum charging time</b>	2.5 hours (to 90%)

### Interface



<b>Wired</b>	no
<b>Wireless</b>	LR WPAN 2.4 GHz IEEE 802.15.4



BV Cert. 7359982

# electric wheel Series 300F

Developed for the food processing industry

All the components necessary for traction are built into the wheel: an electric gear motor, high energy and long-life batteries, a power controller ensuring optimum motor control, battery management and a control interface.



- Ø 304 mm
- 1000 kg moved
- IP69K
- 50 sh.A Polyurethane enhanced grip

Ref. ezW300F/W



**Uses**

- rolling equipment for harsh environment
- pusher/puller
- food processing material

**Technical features**

<b>Diameter</b>	304 mm
<b>Speed range</b>	0 to 9 km/h
<b>Peak pushing effort</b>	35 daN Moves 1000 kg
<b>Nominal performance</b>	12 daN at 6 km/h
<b>Maximum rolling speed</b>	12 km/h
<b>Battery capacity</b>	240 Wh
<b>Wheel weight</b>	17 kg
<b>Feature</b>	Stainless Steel recharge per contact

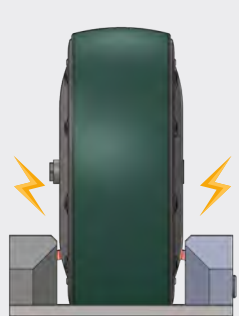

+
 FEATURE

**Recharge per contact**  
Enables the built-in battery to be recharged by direct contact on wheel sides.



## Weight

The robust assembly can withstand knocks and severe vibration and enables the wheel to carry some load.

**17 kg**

Wheel weight

**300 kg**

Vertical load

## Conditions of use

The wheel can be used inside or outside, over a wide range of temperatures. The components – including the battery – do not need any inspection or maintenance over the product's whole lifespan.

**-20°C**  
**+60°C**

Functional  
temperatures range

**5Y.**  
**7Y.**

Maintenance period  
in years

## Applications examples

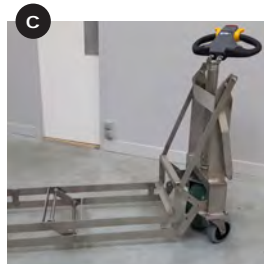

- a. Mobile tank
- b. Pusher/puller
- c. Drum trolley

## Components specifications

### Motor

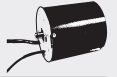

<b>Technology</b>	BLDC PM
<b>Gearbox</b>	1-stage helical
<b>Indicative lifespan</b>	5000 h / 15000 km 1500 000 starts/stops
<b>Nominal Speed</b>	110 rpm (6,2 km/h)
<b>Nominal power</b>	200 W (S1)
<b>Peak Torque</b>	52 Nm

### Battery



<b>Electro-chemistry</b>	Ni-MH long life
<b>Energy</b>	240 Wh 24 VDC - 10 Ah
<b>Indicative lifespan</b>	5-8 years
<b>Recharge mode</b>	Charger
<b>Minimum charging time</b>	2.5 hours (to 90%)

### Interface



<b>Wired</b>	no
<b>Wireless</b>	LR WPAN 2.4 GHz IEEE 802.15.4

# electric wheel Series 150I

Developed for industrial use



BV Cert. 7359982

All the components necessary for traction are built into the housing: an electric gear motor, high energy and long-life batteries, a power controller ensuring optimum motor control, battery management and a control interface.

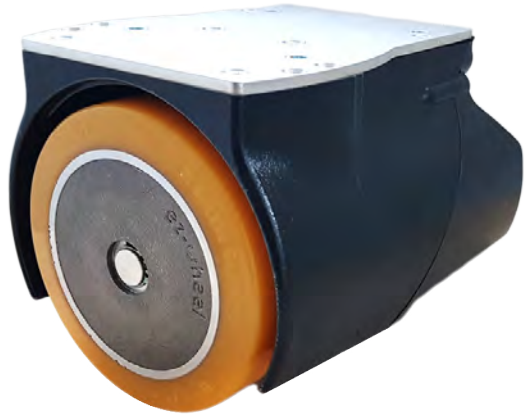

- Ø 150 mm
- 1000 kg moved
- IP43
- 92 sh.A Blicke® Extrathane flat profile

**Ref. ezW150I**

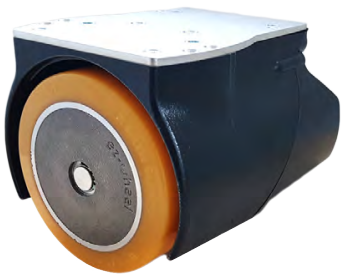

**Uses**

- industrial trolleys
- rolling equipment for factories
- mobile workstations and tools

**Technical features**

<b>Diameter</b>	150 mm
<b>Speed range</b>	0 to 5 km/h
<b>Peak pushing effort</b>	35 daN Moves 1000 kg
<b>Nominal performance</b>	15 daN at 4 km/h
<b>Maximum rolling speed</b>	8 km/h
<b>Battery capacity</b>	0 - 70 - 140 Wh
<b>Wheel weight</b>	10 kg
<b>Options +</b>	Parking brake /B Additional battery

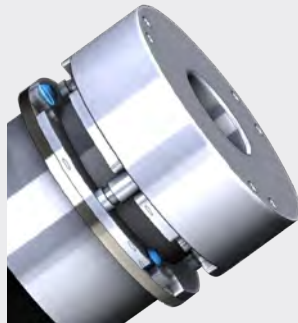

OPTION +

**Parking brake**

Electro-mechanical parking brake.  
Ref. /B

Only available on:  
✓ ezW150I



OPTION +

**Additional battery**

Internal batteries.  
Ref. ezB24V3AH/160

Delivered separately, to be installed in:  
✓ ezW150I  
✓ ezW160M+

## Weight

Thanks to the reinforced cast iron housing and wheel hub, the Series 150 wheel can withstand knocks and severe vibration and enables the wheel to carry some load.

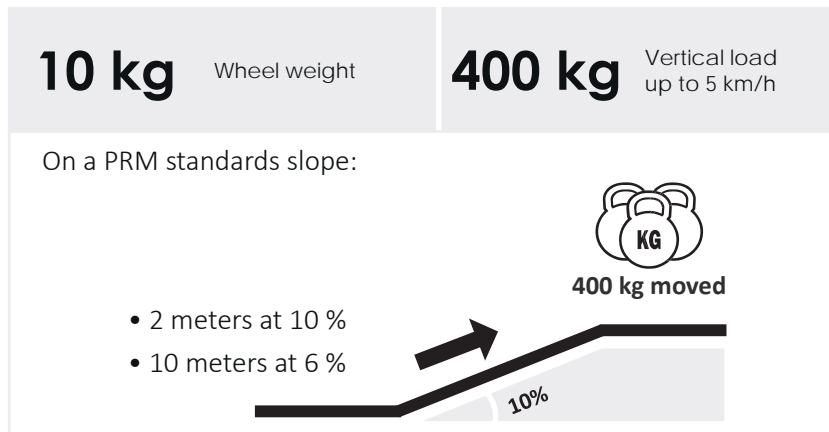

## Conditions of use

The wheel can be used inside or outside, over a wide range of temperatures. The components – including the battery – do not need any inspection or maintenance over the product's whole lifespan.

<b>-10°C</b> <b>+40°C</b>	Functional temperatures range	<b>2Y.</b> <b>3Y.</b>	Maintenance period in years
------------------------------	-------------------------------	--------------------------	-----------------------------

## Applications examples



- Conveyor transfer car
- Tool trolley
- Scissor lift trolley

## Components specifications

### Motor

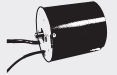

<b>Technology</b>	BLDC PM
<b>Gearbox</b>	2-stage helical
<b>Indicative lifespan</b>	3000 h / 10000 km 1000 000 starts/stops
<b>Nominal Speed</b>	166 rpm (4,7 km/h)
<b>Nominal power</b>	170 W (S3, 15% duty cycle, 5 min max)
<b>Peak Torque</b>	27 Nm

### Battery



<b>Electro-chemistry</b>	Ni-MH long life
<b>Energy</b>	70 Wh (1 battery) 24 VDC - 3 Ah 140 Wh (2 batteries) 24 VDC - 6 Ah
<b>Indicative lifespan</b>	2-3 years
<b>Recharge mode</b>	- Charger - External power
<b>Minimum charging time</b>	1.5 hours (to 90%)

### Interface



<b>Wired</b>	- Analog - Serial / CAN (upon request)
<b>Wireless</b>	no



# electric wheel Series 160M

Developed for the medical environment



BV Cert. 7359982

All the components necessary for traction are built into the wheel: an electric gear motor, high energy and long-life batteries, a power controller ensuring optimum motor control, battery management and a control interface.

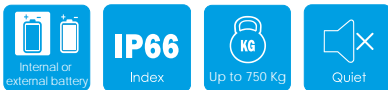

- Ø 158 mm
- 750 kg moved
- IP66
- 70 sh.A Polyurethane flat profile

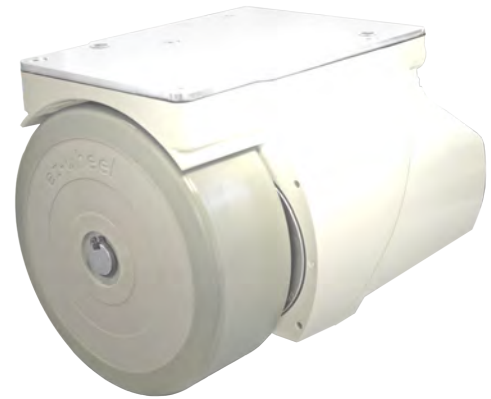

## Ref. ezW160M+

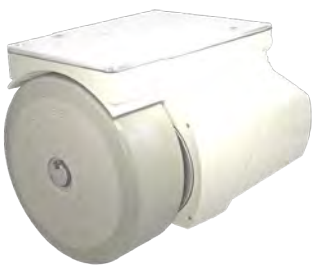

### Uses

- catering trolleys
- transfer chairs and beds
- rolling equipment for hospitals

### Technical features

<b>Diameter</b>	158 mm
<b>Speed range</b>	0 to 5 km/h
<b>Peak pushing effort</b>	27 daN Moves 750 kg
<b>Nominal performance</b>	9 daN at 5 km/h
<b>Maximum rolling speed</b>	8 km/h
<b>Battery capacity</b>	0 - 70 - 140 Wh
<b>Wheel weight</b>	6 kg
<b>Options</b> ⚙️	Additional battery



# OPTION +



### Additional battery

Internal batteries.  
Ref. **ezB24V3AH/160**

Delivered separately, to be installed in:

- ✓ ezW150I
- ✓ ezW160M+

## Weight

The robust assembly can withstand knocks and severe vibration. The wheel is designed to be installed as a fifth wheel with a suspension.

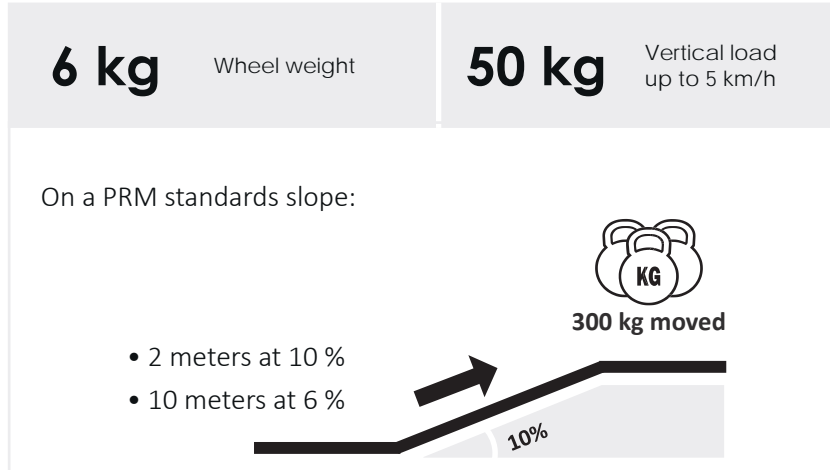

## Conditions of use

The wheel can be used inside or outside, over a wide range of temperatures. The components – including the battery – do not need any inspection or maintenance over the product's whole lifespan.

<b>-10°C</b> <b>+40°C</b>	Functional temperatures range	<b>2Y.</b> <b>3Y.</b>	Maintenance period in years
------------------------------	-------------------------------	--------------------------	-----------------------------

## Applications examples

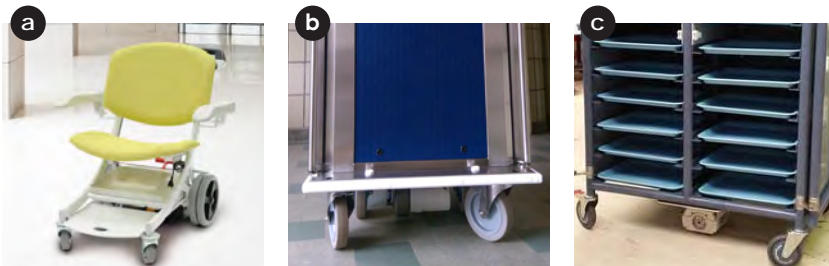

- Transfer chair
- Hot & cold food cart
- Catering trolley

## Components specifications

### Motor

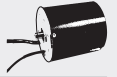

<b>Technology</b>	BLDC PM
<b>Gearbox</b>	2-stage helical
<b>Indicative lifespan</b>	2000 h / 5000 km 600 000 starts/stops
<b>Nominal Speed</b>	167 rpm (5 km/h)
<b>Nominal power</b>	130 W (S1)
<b>Peak Torque</b>	22 Nm

### Battery



<b>Electro-chemistry</b>	Ni-MH long life
<b>Energy</b>	70 Wh (1 battery) 24 VDC - 3 Ah 140 Wh (2 batteries) 24 VDC - 6 Ah
<b>Indicative lifespan</b>	2-3 years
<b>Recharge mode</b>	- Charger - External power
<b>Minimum charging time</b>	1.5 hours (to 90%)

### Interface



<b>Wired</b>	- Analog - Serial
<b>Wireless</b>	no

# electric wheel Series 10"

Developed for the outdoors



All the components necessary for traction are built into the wheel: an electric gear motor, high energy and long-life batteries, a power controller ensuring optimum motor control, battery management and a control interface.



- Ø 400 mm
- 150 kg moved
- IP54
- 10x4 road tyre



## Ref. ezW10R/W



### Uses

- delivery carts
- land drone

### Technical features

Diameter	400 mm
Speed range	0 to 15 km/h
Peak pushing effort	-
Nominal performance	250 W (S1 at 10m/h)
Maximum rolling speed	18 km/h
Battery capacity	240 Wh
Wheel weight	14,5 kg
Option	-



## Weight

The robust assembly can withstand knocks and severe vibration and enables the wheel to carry some load.

**14,5 kg** Wheel weight

**150 kg** Recommended maximum load per wheel on a 10% slope

## Conditions of use

The wheel can be used inside or outside, over a wide range of temperatures. The components – including the battery – do not need any inspection or maintenance over the product's whole lifespan.

**-20°C**  
**+60°C** Functional temperatures range

**5Y.** Maintenance period in years

## Applications examples

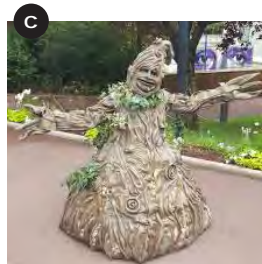
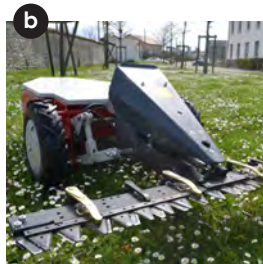

- a. Street trolley
- b. Agricultural drone
- c. Motorized parade/float character

## Components specifications

### Motor

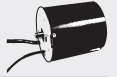

<b>Technology</b>	BLDC PM
<b>Gearbox</b>	1-stage helical
<b>Indicative lifespan</b>	5000 h / 15000 km 1500 000 starts/stops
<b>Nominal Speed</b>	240 rpm (18 km/h)
<b>Nominal power</b>	250 W (S1 at 10 Km/h)
<b>Peak Torque</b>	55 Nm

### Battery



<b>Electro-chemistry</b>	Ni-MH long life
<b>Energy</b>	240 Wh 24 VDC - 10 Ah
<b>Indicative lifespan</b>	> 5 years
<b>Recharge mode</b>	Charger
<b>Minimum charging time</b>	3 hours (to 90%)

### Interface



<b>Wired</b>	-
<b>Wireless</b>	Wireless (LR WPAN) 2.4 GHz Based on IEEE 802.15.4

# ez-Config® software

## Configure your wheel

ez-Config® is the core of the ez-Wheel® solutions. Thanks to their open connectivity, wheels and hand controls are programmable and can be perfectly adapted to any situation.



**Environment**  
Evaluate and understand the working place characteristics





**Connection**  
Open ez-Config® and connect ez-Wheel® devices via a USB port





**Configuration**  
Configure wheels and accessories  
Save parameters

**EN** English interface



Windows compatibility  
7 and above



Offline support

### Available versions:

<b>Ref. ez-Config/300</b>	Configuration software suitable for:	<ul style="list-style-type: none"> <li>✓ Series 300</li> <li>✓ Series 10"</li> <li>✓ Smart controls</li> </ul>
<b>Ref. ez-Config/150-160</b>	Configuration software suitable for:	<ul style="list-style-type: none"> <li>✓ Series 160</li> <li>✓ Series 150</li> </ul>

## Features specifications:

This set of intuitive features have been developed and adapted thanks to years of return on experience and meet every user's demands.

### KM/H

#### Speed definition

Define the speed of the wheel.  
Forward and Backward speed can be differentiated.

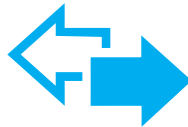

#### Direction change

Adjust the behaviour of the wheel during a change in the set direction.  
2 modes are available: «Deceleration» and «Inversion».



#### Max speed mode

Set up the behaviour of the wheel when the rolling speed exceeds the maximum speed value entered in ez-Config®.



#### Acceleration time

Set up the acceleration time according to your needs.  
e.g. slow for patient moving, fast for picking trolley.



#### Deceleration mode

Choose the deceleration behaviour when releasing the hand control.  
e.g. motor brake resistance, free wheel to continue rolling.



#### Start time limiter

Limit the motor drive time for each start. When the hand control is released the wheel goes back to the selected deceleration mode.



#### Auto stand-by

Enter a value in seconds corresponding to the waiting time between the absence of activity on the hand control and switching back to stand-by.

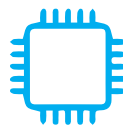

#### Inputs Outputs

Configure external interfaces for the displays, buttons, external supply...



Free of charge software



ID login & Password on demand





# ez-Wheel® devices

High level of compatibility

ez-Wheel® products have been developed to be integrated into many applications in various environments. Hundreds of accessories combinations are possible thanks to the high level of compatibility!

Wheels and accessories are designed to ensure a plug-and-play compatibility. ez-Wheel's catalogue features a full range of wireless controls and predefined cables, ready to use.

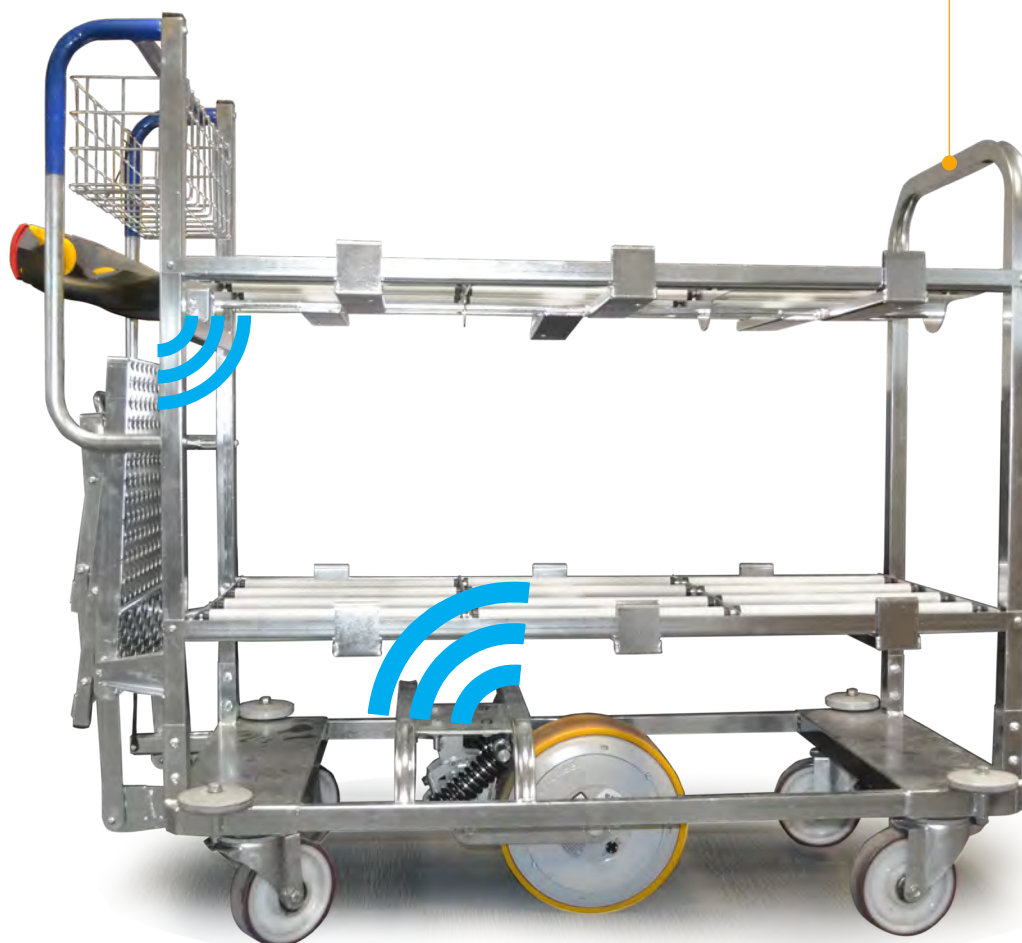



# Product compatibility

<b>ezW300I/WR</b>	<b>ezW300I/CCR</b>	<b>ezW300M/W</b>	<b>ezW300F/W</b>	<b>ezW150I</b>	<b>ezW160M</b>	<b>ezW10R/W</b>

## Controls compatibility

					No	No	
<b>ezRTH/W</b>							
			No	No	No	No	No
<b>ezRPP/UC</b>		<b>ezUCxM</b>					
					No	No	
<b>ezR44IN/W</b>							
	No		No	No	No	No	No
<b>ezR44IN/U</b>		with <b>ezACxM-UC/Box</b> and <b>ezUCxM</b>					
					with <b>ezACxM-BD/160</b>	with <b>ezACxM-BD/160</b>	
<b>Wired control ezAxxx</b>							
	No	No	No	No	with <b>ezACxM-BD/160</b>	with <b>ezACxM-BD/160</b>	No
<b>ezARH-BD</b>							

## Switches compatibility

					with <b>ezACxM-BD/160</b>	with <b>ezACxM-BD/160</b>	
<b>Switches ezSxxx</b>							
	No	No	No	No	with <b>ezACxM-BD/160</b>	with <b>ezACxM-BD/160</b>	No
<b>ezSPBC-BD</b>							
	No	No	No	No	<b>Cable included</b>	<b>Cable included</b>	No
<b>Emergency button ezSExxx</b>							

## Internal and External batteries

	No	No	No	No	<b>Cable included</b>	<b>Cable included</b>	No
<b>ezB24V3AH/160</b>							
	No	with <b>Mascot1A8/BAT</b>	No	No	with <b>ezBCEXT/160</b> or <b>ezBCEXMxM/160</b>	with <b>ezBCEXT/160</b> or <b>ezBCEXMxM/160</b>	No
<b>External battery</b>							

# Wireless tiller head control

Bi-directional and ergonomic

Ensures a proper handling of equipment thanks to ergonomic shapes and well organised commands. The integrated wireless interface allows a simple and quick integration on rolling equipment.

## Other functions:

The interface remotely displays the battery level of the wheel and the system status. It is powered by its own internal battery.

**Ergo** Ergonomic control

**IP54**  
**IP65** Protection Index

## Which tiller head for which use?

Ref. ezRTH/W



**Uses**

- pusher/puller
- industrial hand trucks
- heavy load carriers

**Technical features**

**Functions** On/Off button  
Progressive accelerator

**Protection Index** IP54

**Communication** Wireless

**Compatibility** ✓ Series 300  
✓ Series 10''

Ref. ezRTH/W/IP



**Uses**

- pusher/puller
- food processing machines
- outdoor applications

**Technical features**

**Functions** On/Off button  
Progressive accelerator  
Warning horn  
Charge & USB plugs caps  
Sealed inner components

**Protection Index** IP65

**Communication** Wireless

**Compatibility** ✓ Series 300  
✓ Series 10''





Stainless-Steel stopper under **ezRTH/W/IP** tiller head. To protect the charge connector against washing water jets.



**ezRTH/W**: an award-winning tiller head housing, combining ergonomics and robustness, fitted with the best control features from ez-Wheel.



# Push pull sensitive control

Bi-directional and sensitive sensor

Ensures a natural handling of equipment thanks to sensitive sensors, ergonomic shapes and intuitive use.

## Other functions:

The interface remotely displays the battery level of the wheel and the system status. Its magnetic connector ensures a quick charger connection when coming back to the parking station.

**Ergo** Ergonomic control



Magnetic connector for immediate and easy connection

## Push Pull Sensitive control:

Ref. ezRPP/UC



**Uses**

- towed trailers

**Technical features**

**Functions**  
 Pressure sensors in push and pull directions  
 On/Off button  
 Progressive accelerator  
 Battery and status indicator

**Protection Index** IP54

**Communication** Serial  
 Wireless

**Compatibility** ✓ ezW300I/CCR

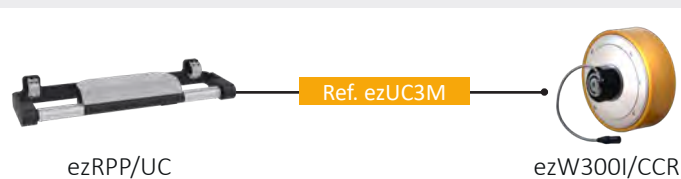

Cables compatibility



**ezRPP:** an intuitive control bringing best practices in lean manufacturing, co-designed with automotive players, for automotive players.

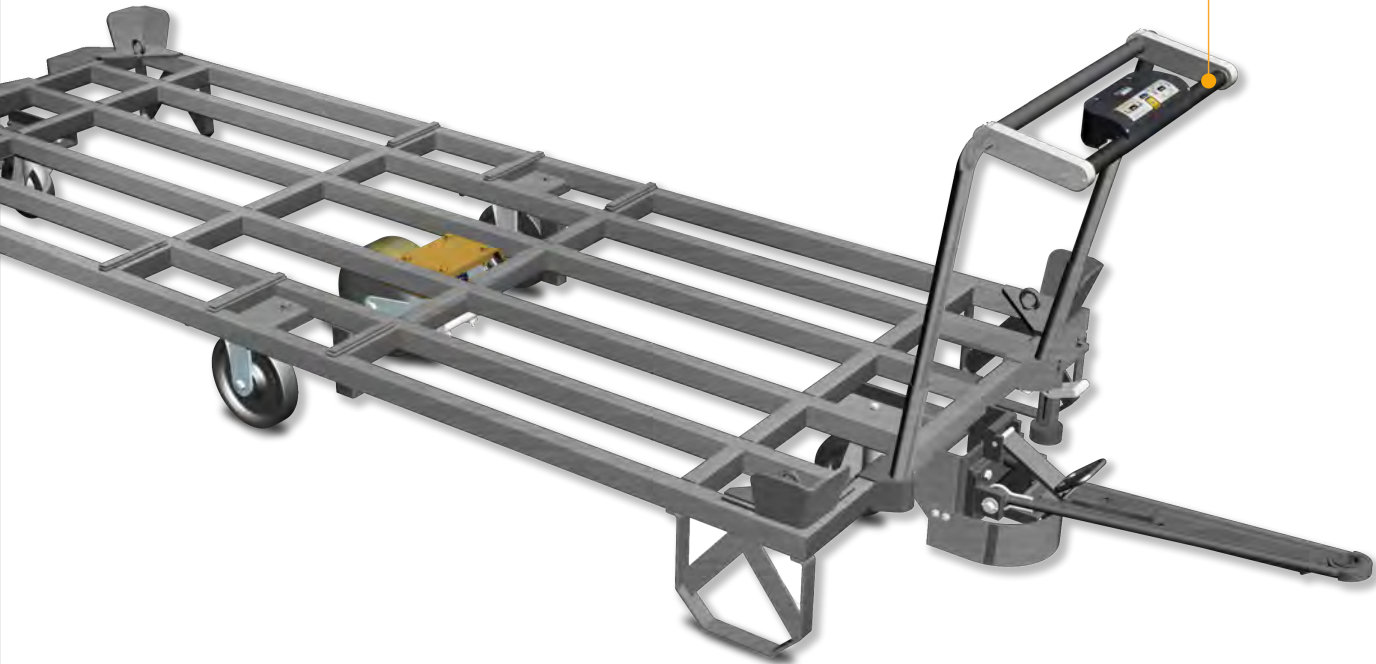

# The ez-Box® interface

Control one or two wheels

## Wireless Communication /W

The wireless interface allows a simple and quick integration on rolling equipment.

## Serial Link Communication /U

The serial link is used in ez-Wheel solutions for insuring a wired communication recommended for noisy environments or wireless restricted areas.



Displays the battery level of the wheel and the system status



Panel or tube mount

## ez-Box® interface:

Ref. ezR44IN/W



### Uses

- remotely controls one or two wheel(s)
- the wheel control is ensured by a wired control connected to the ez-Box® wireless interface

### Technical features

<b>Communication</b>	Wireless 2.4 GHz
<b>Protocol</b>	IEEE 802.15.4
<b>Battery</b>	Ni-MH rechargeable
<b>Dimensions</b>	124 x 75 x 27 mm
<b>Compatibility</b>	<ul style="list-style-type: none"> <li>✓ Series 300</li> <li>✓ Series 10''</li> </ul>

Ref. ezR44IN/U



### Uses

- controls one ezW300I/CCR wheel
- uses a serial protocol to ensure an effective bi-directional dialogue between the wheel and ez-Box®

### Technical features

<b>Communication</b>	Serial
<b>Protocol</b>	-
<b>Battery</b>	Ni-MH rechargeable
<b>Dimensions</b>	124 x 75 x 27 mm
<b>Compatibility</b>	✓ ezW300I/CCR





## Which box for which use?

- ✓✓ Highly recommended
- ✓ Compatible
- ✗ Not recommended



Environment informations	Wireless communication	Serial link communication
White RF noise environment	✗	✓✓
Wireless restricted areas	✗	✓✓
Agro/pharma environment (300M/300F)	✓✓	✗
Humid environment	✓✓	✗
Two wheels system	✓✓	✓

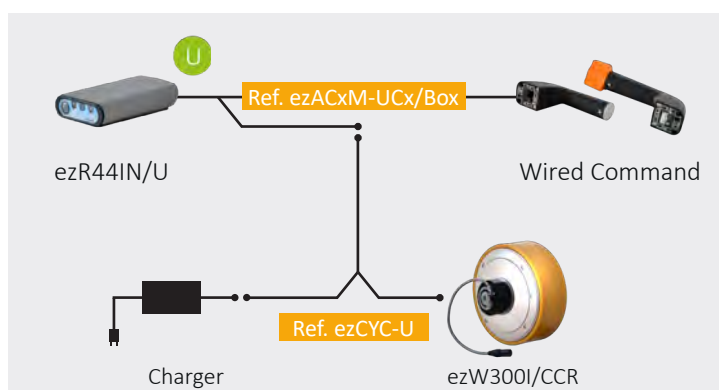
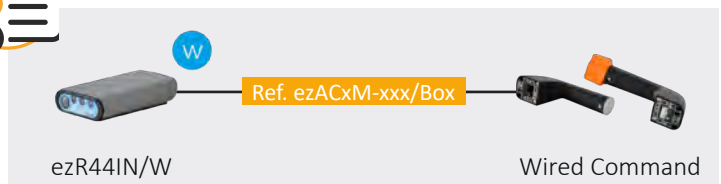

Cables compatibility

# Wired hand controls

## Wired and Bi-directional



Ref. ezAARmini

### Mini joystick

This finger operated mini joystick can control the speed in both directions (forward and backward). It can be mounted at the end of a tube, or on a panel.

Suitable for:	Cable required
✓ ez-Box®	Ref. ezACxM/Box
✓ Series 150/160	Ref. ezACxM-BD/160



Ref. ezAAR

### Joystick

The joystick can control the speed in both directions (forward and backward). It can be mounted on a panel and is suitable for tough environments.

Suitable for:	Cable required
✓ ez-Box®	Ref. ezACxM/Box
✓ Series 150/160	Ref. ezACxM-BD/160



Ref. ezARH

### Rotating handle

The ezARH controls the speed in both directions (fwd and bck) with the thumb. The handle features an ergonomic and very rugged design.

Suitable for:	Cable required
✓ ez-Box®	Ref. ezACxM/Box
✓ Series 150/160	Ref. ezACxM-BD/160



Ref. ezARH-BD

### Rotating handle with button and display

The ezARH-BD controls the speed in both directions (fwd and bck) with the thumb. The handle features an ergonomic and very rugged design. The second handle is equipped with a battery display and a start button.

Suitable for:	Cable required
✓ Series 150/160	Ref. ezACxM-BD/160



Ref. ezAFB

## Forward & Backward control

This simple button control is suitable for a basic forward and backward operation (non-progressive).

Suitable for:	Cable required
✓ ez-Box®	Ref. ezACxM/Box
✓ Series 150/160	Ref. ezACxM-BD/160



Ref. ezATH

## Tiller head

The ezATH command is a tiller head type control. It ensures a proper handling of equipment thanks to ergonomic shapes and well organized commands. It can control the speed in both directions (forward and backward). For safety, the control includes a belly button.

Suitable for:	Cable required
✓ ez-Box®	Ref. ezACxM/Box
✓ Series 150/160	Ref. ezACxM-BD/160

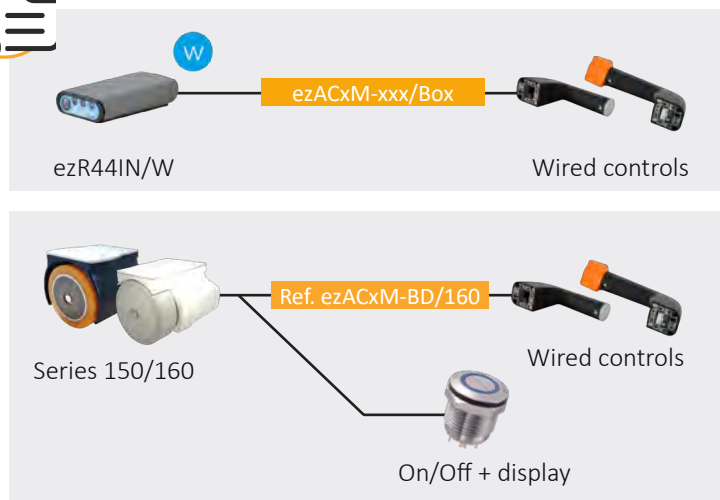

Cables compatibility

# Wired switches

## Standard switches



Ref. ezSONF-B

### Switch On/Off Button

The ezSONF-B is a bistable toggle switch, to start and stop the system.

Suitable for:	Cable required
✓ ez-Box®	Ref. ezACxM-UCB/Box
✓ Series 150/160	Ref. ezACxM-BD/160



Ref. ezSKEY-B

### Switch Key Button

The ezSKEY-B is a bistable key switch, to secure the start of the system.

Suitable for:	Cable required
✓ ez-Box®	Ref. ezACxM-UCB/Box
✓ Series 150/160	Ref. ezACxM-BD/160



Ref. ezSPBC-BD

### Switch Push Button Colour

The ezSPBC-BD is an impulse push button featuring a status or battery level LED display.

Suitable for:	Cable required
✓ Series 150/160	Ref. ezACxM-BD/160



Ref. ezSEMRxM/160

### Switch Emergency

The ezSEMRxM/160 is an emergency push button, to disconnect the motor power on Series 150/160 wheels.

Suitable for:	Cable required
✓ Series 150/160	Included



Ref. ezSERBxM/160

### Switch Emergency Reverse Button

The ezSERBxM/160 is an emergency reverse button, to secure an operator trapped between the tiller head and an obstacle.

Suitable for:	Cable required
✓ Series 150/160	Included



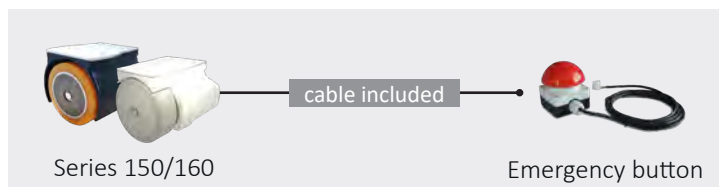
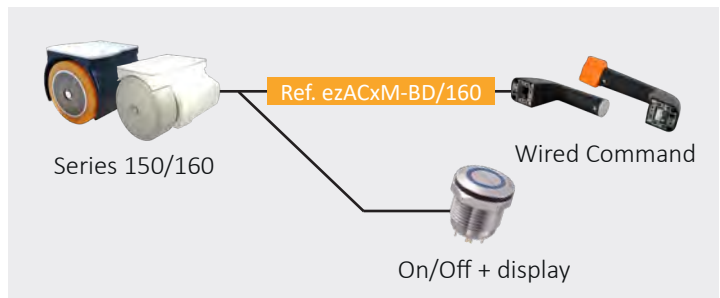
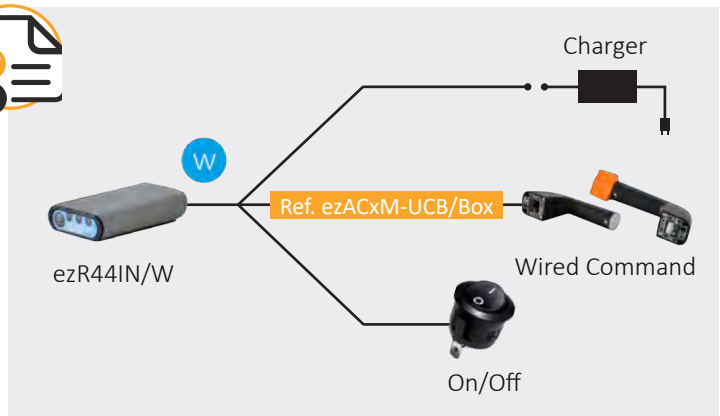

Cables compatibility

# Internal battery

For Series 150 & 160



Ref. ezB24V3AH/160

## Internal batteries

Ni-MH 24 VDC - 3 Ah - Extra energy for continuous use

Suitable for:	Cable required
✓ Series 150/160	No

# External batteries

For continuous use



Ref. ezB24V6AH/L

## External battery with handle

Ni-MH 24 VDC - 6 Ah - Long life

Suitable for:	Cable required
✓ ezW300I/CCR	Ref. Mascot1A8/BAT
✓ Series 150/160	Ref. ezBCEXMxM/160



Ref. ezB24V9AH

## External battery with handle

Ni-MH 24 VDC - 9 Ah

Suitable for:	Cable required
✓ ezW300I/CCR	Ref. Mascot1A8/BAT
✓ Series 150/160	Ref. ezBCEXMxM/160



Ref. ezB24V15AH

## External battery with handle

Ni-MH 24 VDC - 15 Ah

Suitable for:	Cable required
✓ ezW300I/CCR	Ref. Mascot1A8/BAT
✓ Series 150/160	Ref. ezBCEXMxM/160

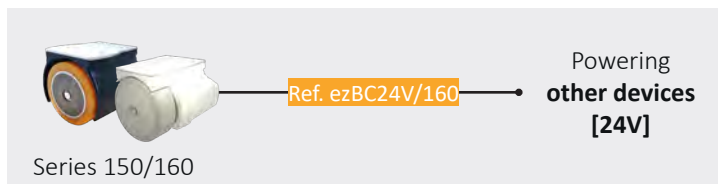
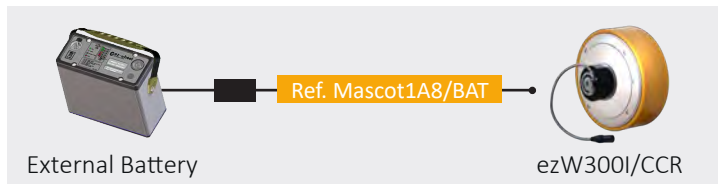
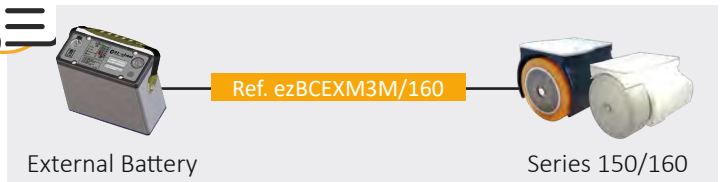

Cables compatibility

# Suspension bracket

Mechanical accessories for **Series 150/160**



## Heavy Duty suspension bracket

The suspension bracket ezMCS/160 features a suspension for height compensation. The ground contact is optimal and the charge on the wheel stays stable, ensuring a good grip for the torque transmission.

✓ Series 150/160

Ref. ezMCS/160



## Compact suspension bracket

The compact suspension bracket ezMCS/L/160 features a suspension for height compensation without increasing footprint. This suspension is suitable for medium loads, up to 500 kg.

✓ Series 150/160

Ref. ezMCS/L/160



## Horizontal suspension bracket with stronger spring force (+)

The suspension bracket ezMCS/L/160+ features a suspension for height compensation. This model is preferred for heavier loads, between 500 and 1000 kg.

✓ Series 150/160

Ref. ezMCS/L/160+



ezMCS/L/160+ on a Series 160 wheel

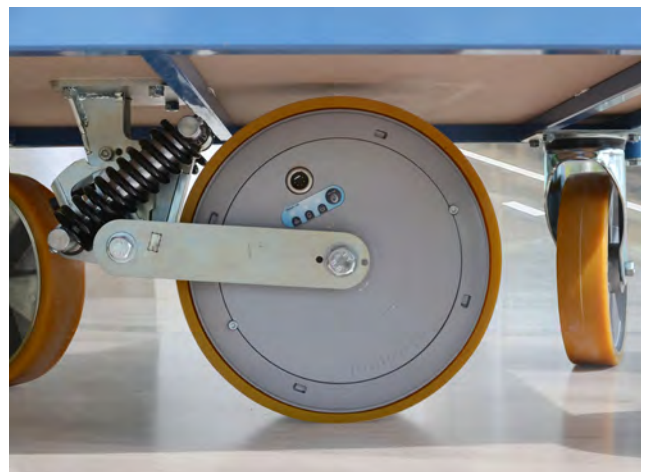

ezMCS/H on a Series 300 wheel



# Suspension bracket

Mechanical accessories for **Series 300**

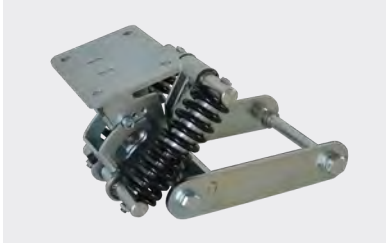

Ref. ezMCS/H

## Horizontal suspension bracket

The suspension bracket ezMCS/H features a suspension for height compensation. The ground contact is optimal and the charge on the wheel stays stable, ensuring a good grip for the torque transmission.

✓ Series 300

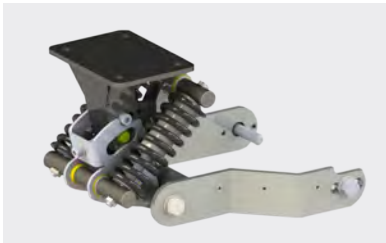

Ref. ezMCS/H/CC

## Horizontal suspension bracket

The suspension bracket ezMCS/H/CC is a specific version of the ezMCS/H for the Series 300/CC wheels. It includes collars to attach the wheel's cable output.

✓ ezW300I/CCR

# Accessories

Mechanical accessories for **Series 300 & 10''**



Ref. ezMAR

## Anti-rotate ring

The ezMAR is used to block the rotation of the wheel's axis, ensuring the transmission of the motor torque to the chassis.

✓ Series 300  
✓ ezW300I/CCR  
✓ Series 10''

# ez-Wheel® Chargers

Adapted to ez-Wheel® devices

 Universal plug available

 Universal voltage 90-264 V AC



Ref. Mascot1A8

## Charger 1,8 Amp

1,8 Amps charger  
XLR charge plug + EU power cord

Suitable for:	Cable required
✓ Series 300 et 10''	cable included
✓ Series 150/160	Ref. ezCCxM/160



Ref. Mascot1A8/IP

## Charger 1,8 Amp IP67

1,8 Amps charger IP67  
XLR charge plug + EU power cord

Suitable for:	Cable required
✓ Series 300 et 10''	cable included
✓ Series 150/160	Ref. ezCCxM/160



Ref. Mascot4A

## Charger 4 Amp

4 Amps charger  
XLR charge plug + EU power cord

Suitable for:	Cable required
✓ Series 300 et 10''	cable included
✓ Series 150/160	Ref. ezCCxM/160



Ref. Mascot1A8/160

## Embedded charger 1,8 Amp

Charger for Series 150/160 (embedded)  
Molex charge plug + EU power cord

Suitable for:	Cable required
✓ Series 150/160	cable included

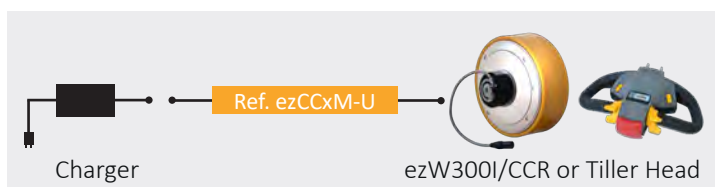
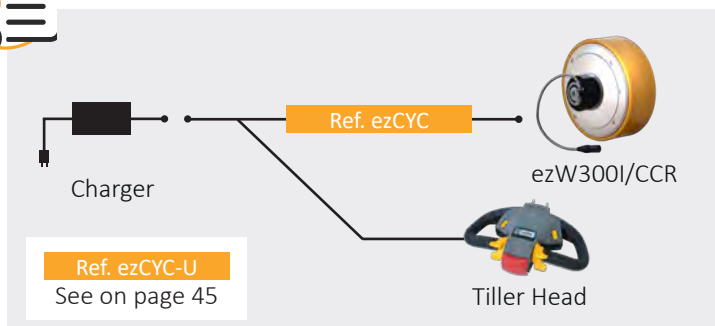

Cables compatibility



# A Worldwide Distribution network

ez-Wheel relies on a strong worldwide distribution network, highly-experienced and specialising in mobility and logistics needs.

**Contact our expert partners!**



**A strong and specific expertise in motorization**

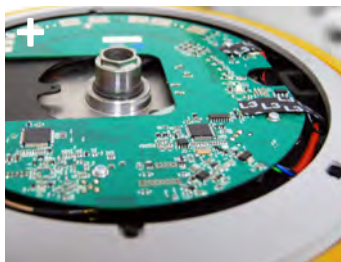

**Dedicated local product assistance**



**Smart tools for field support**



# Who are you?

An end user, an integrator, a manufacturer?



## End User

1



Visit our website **ez-wheel.com**  
heading **contact**

2



Complete the **online form**

3



Our sales network will get back to you and connect you with **local integration partners**

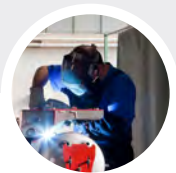

## Integrator

1



Visit our website **ez-wheel.com**  
heading **contact**

2



Complete the **online form**

3



Our sales network will provide you with **all the necessary technical data to properly integrate our products**

(We will be pleased to welcome you to our network of qualified integration partners!)



## OEM / Manufacturer

1



Visit our website **ez-wheel.com**  
heading **contact**

2



Complete the **online form**

3



Our technical experts will define with you the **best solutions to power your devices**

(Customized solutions available for high volumes)



# References Index

Wheels							p.22	
ez-Wheel	Wheel	Diameter	Rubber	Communication	Function/option		p.22	
ez	W	300	I	/ W	R		p.24	
				/ CC	R		p.24	
			M	/ W			p.26	
			/ W			p.28		
		150	I	/		B		p.30
		160	M					p.32
10	R	/ W				p.34		
Software							p.36	
ez-Wheel	Configuration				Compatibility		p.36	
ez	Config				/ 300		p.36	
	Config				/ 150-160		p.36	
Smart controls							p.40	
ez-Wheel	Remote	Kind		Communication	Function		p.40	
ez	R	TH		/ W			p.40	
	R	TH		/ W	/ IP		p.40	
	R	PP		/ UC			p.42	
	R	44IN		/ W			p.44	
	R	44IN		/ U			p.44	
Wired controls							p.46	
ez-Wheel	Action	Kind	Detail				p.46	
ez	A	ARmini					p.46	
	A	AR					p.46	
	A	RH					p.46	
	A	RH	-BD				p.46	
	A	FB					p.47	
	A	TH					p.47	
Wired switches							p.48	
ez-Wheel	Switches	Kind	Detail	Size	Compatibility		p.48	
ez	S	ONF	-B				p.48	
	S	KEY	-B				p.48	
	S	PBC	-BD				p.48	
	S	EMR		xM	/ 160		p.48	
	S	ERB			xM	/ 160	p.48	
Internal batteries							p.50	
ez-Wheel	Battery	Detail	Detail		Compatibility		p.50	
ez	B	24V	3AH		/ 160		p.50	
External batteries							p.50	
ez-Wheel	Battery	Detail	Detail	Detail			p.50	
ez	B	24V	6AH	/ L			p.50	
	B	24V	9AH				p.50	
	B	24V	15AH				p.50	



# References Index

Mechanical accessories							p.52
ez-Wheel	Mechanical accessories		Detail			Compatibility	
	MCS					/ 160	p.52
	MCS	/	L			/ 160	p.52
ez	MCS	/	L			/ 160+	p.52
	MCS	/	H				p.53
	MCS	/	H			/ CC	p.53
	MAR						p.53
Cables							
ez-Wheel	Accessories		Size	Detail		Compatibility	
	AC		xM	-BD		/ 160	p.47/49
ez	AC		xM	-UC		/ Box	p.45
	AC		xM	-UCB		/ Box	p.45/47/49
ez-Wheel	Charge Y cable					Compatibility	
	CYC						p.55
ez	CYC					- U	p.45/55
ez-Wheel	Charge cable				Size	Compatibility	
	CC				xM	- U	p.55
ez	CC				xM	/ 160	p.55
	CC					/ MAG	p.43
ez-Wheel	Charge & communication cable				Size	Compatibility	p.43
ez	UC				3M		p.43
ez-Wheel	Battery cable		Detail		Size	Compatibility	p.51
	BC		24V			/160	p.51
ez	BC		EXT			/160	p.51
	BC		EXM		xM	/160	p.51



**ez-Wheel SAS with a capital of 449 332 € - RCS Angoulême: 518 704 887**

**Copyright © 2021 ez-Wheel company. All right reserved. Reproduction prohibited without authorization.**

*Pictures credit: ez-Wheel, Adobe Stock*

*Balin SAS, Torwegge GmbH, Bloomberg TV, Bibus Group AG, Serap Industries, Signature Logistic, C-Logistics, BMB Medical, Altius Diffusion, Nouansport, DOSTA GmbH, effets-speciaux.info, Scania.*



Consult case studies, media,  
datacenter and our latest news at:  
[www.ez-wheel.com](http://www.ez-wheel.com)



### INDUSTRY



### AUTOMOTIVE



### FOOD PROCESSING



### LOGISTICS / RETAIL



### MEDICAL / PHARMACEUTICAL



### PUBLIC SPACES



## ez-Wheel SAS

📍 Le Moulin de l'Abbaye, 135 Route de Bordeaux, 16400 La Couronne - FRANCE

✉ [info@ez-wheel.com](mailto:info@ez-wheel.com) **Tel :** +33 531 615 580